



**Antique
Slot Machine
Parts
Catalog**

**Antique Slot Machine Part Co
920-622-5959**



Antique Slot Machine Part Co. originated out of a twenty-five year interest in coin operated machines. As collectors of antique machines we have seen a growing demand for originality in restoring antique machines. We are constantly looking for and acquiring original parts, but also have recognized the need to supply good quality replacements so a machine can be put together in operating condition. The parts offered for sale are sold for the purpose of repairing and restoring antique machines.

The parts pictured in the first part of this catalog are the most commonly replaced parts in restoring machines. In the latter part we have pictured almost every internal part for the Mills and Jennings machines. All of the Mills and most of the Jennings parts are available on request. If you have a Pace, Watling or Caille machine and cannot find the part you need in this catalog, please request a part manual for your specific machine to help identify the part you need.

For your convenience we are selling parts, castings and cabinets in various stages of restoration. This allows you the option of assembling a machine from parts or combining a restored mechanism with unrestored castings and an unfinished cabinet. We do offer an excellent selection of restored slot machines and other related antique coin operated machines.

If you have any questions as to what you might need, give us a call or stop by, we would be happy to help you in whatever way we can. We are open to buying, selling, trading or making a deal with you. We would like to thank you for your enthusiasm in collecting coin operated machines and are looking forward to working together in the future to further our unique hobby. Slot machines are destined to become prized possessions, conversation pieces in our homes and excellent investments to play.



TABLE OF CONTENTS

Award cards	26,28,31 thru 37	Handles	14
Back bonnets	4	Jackpots	20,54,59
Back doors	6,8	Jennings Indians	30
Back lips	22	Jennings Challenger parts	44
Base plates	30	Jennings Internal parts	55 thru 62
Bonus parts	14	Locks & keys	6
Books & manuals	28	Marquees	24
Cabinets	8	Mills internal parts	49 thru 54
Cabinet hardware	8	Mint vendor parts	16,22
Cashboxes	10,12	Misc	14,22
Casting kits	45,46	Money bowls	12
Casting hardware	16	Paint	8
Clocks	20,53,59	Reel assembly parts	14,51
Console parts	43,44	Slides & related parts	18,50,61
Decals	22,26	Slot stands	47,48
Denominator buttons	16	Springs	14
Escalators	18,53,61	Stencils	8
Frames	22,24	Strips	38 thru 42
Gifts	43,44	Swivel base	8
Glass	44	Tokens	22
Golden Nugget set	16	Vest Pocket feet	14
		Watling misc. parts	22

DELIVERY: All orders will be processed the same day as received if possible. All orders will be sent UPS unless requested to be sent by mail. Please avoid P.O. Box addresses if requesting UPS delivery.

ORDERING: When ordering use part number and description and price. Other parts which are not listed are available on request.

TERMS: All orders are paid in advance unless other arrangements are made. Orders may be sent C.O.D. .. Orders may be paid by cash, certified check or money order made payable to Antique Slot Machine Part Co. or T. Krahl, Visa or Master Charge, or personal checks will be accepted, but with a ten day wait. Once an account has been established, personal checks will receive immediate attention. All shipping charges are C.O.D. unless other arrangements are made. Illinois residents add Sales Tax, dealers please submit a tax I.D. number.

RETURNS: Any item returned to us must receive our notification and be received within 30 days of invoice for refund, exchange or credit.

GUARANTEE: If for any reason you are not completely satisfied with any item purchased from us, your money will be promptly refunded.

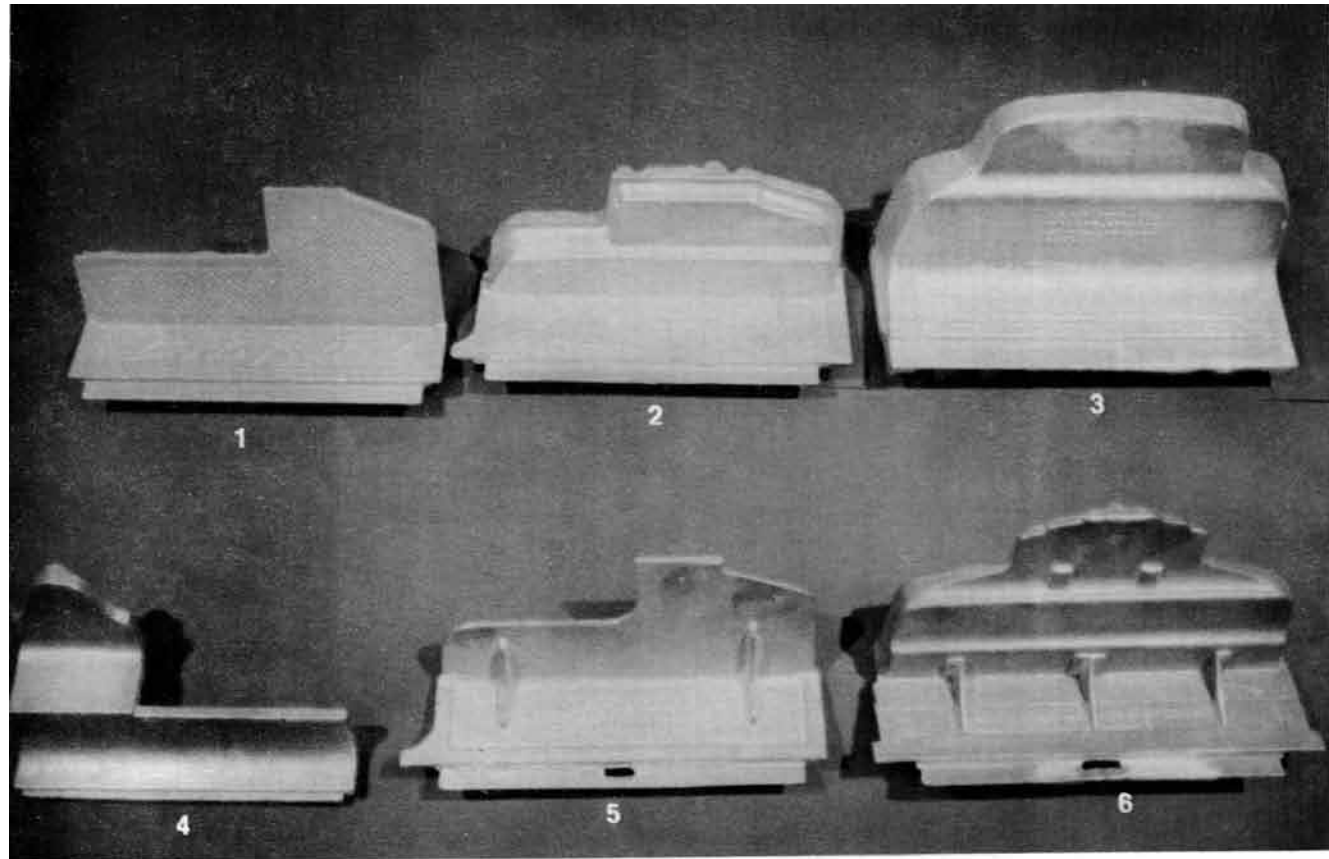

BACK BONNETS

- 1 - Jennings Victoria Silent Peacock
- 2 - Jennings 4-Star Chief
- 3 - Jennings Standard Chief
- 4 - Jennings Today Vendor
- 5 - Jennings 1-Star
- 6 - Jennings Sportsman
- 7 - Mills - fits War Eagle, Blue Front, Castle Front, Bursting Cherry and Romanhead
- 8 - Mills - fits Black Cherry, Diamond Front and Golden Falls
- 9 - Watling Rol-A-Top
- 10 - Mills Hi-Top
- 11 - Jennings -fits Bronze Chief and Victoria Chief
- 12 - Mills Extraordinary
- 346 - Buckley

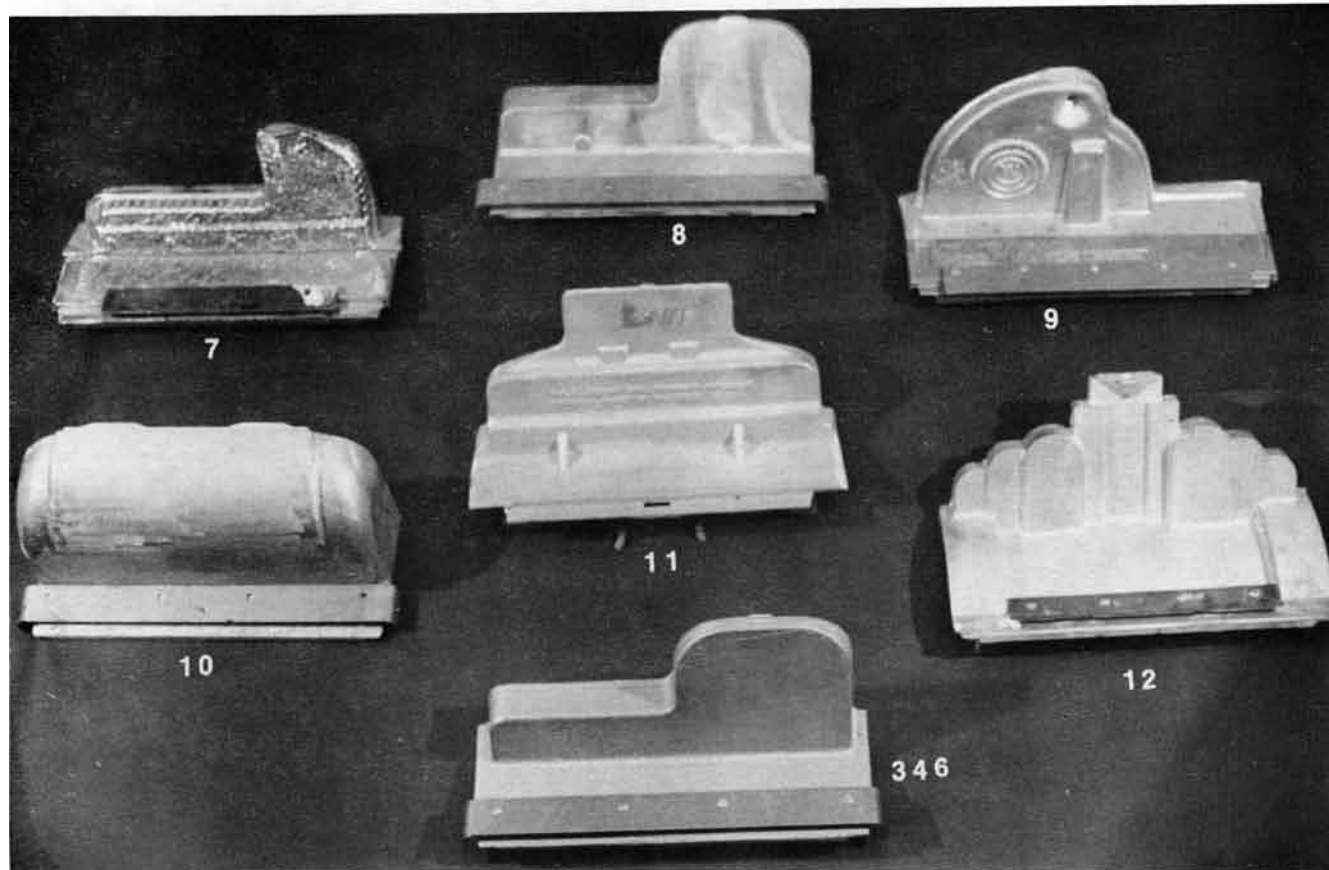

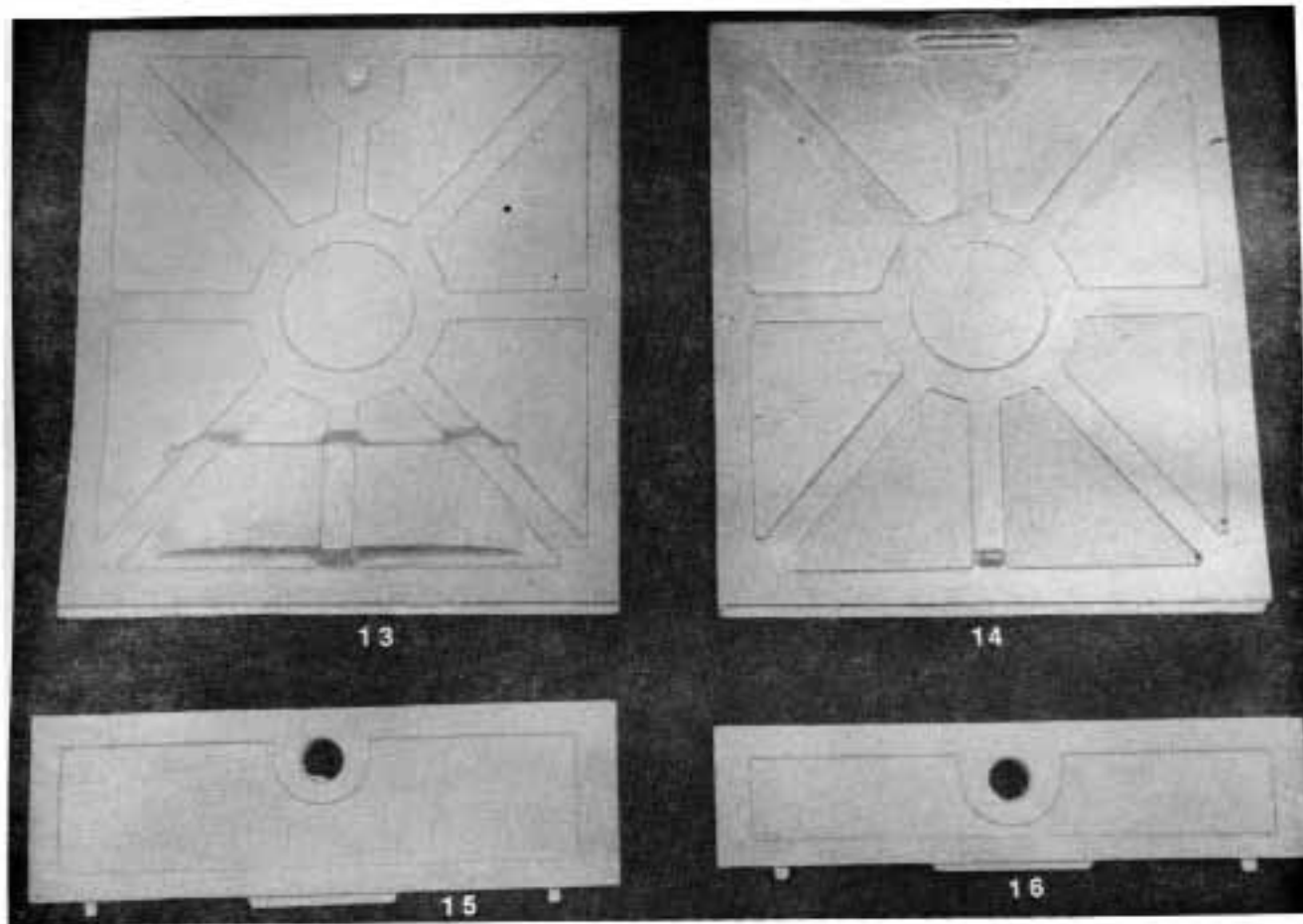

BACK DOORS (CAST ALUMINUM)

- 13 - Jennings Top - 1-Star, 4-Star (13" x 14-1/4")
 - 14 - Jennings Top - 1930 Model (12-3/4" x 14-5/8")
 - 15 - Jennings Bottom - (3-3/4" x 12-5/8")
 - 16 - Jennings Bottom - (3" x 12-3/4")
- Other Jennings tops and bottoms available on request
Please send exact measurement of door.

LOCKS AND KEYS

- 17 - Mills lock and key - original for back door
- 18 - Jennings lock and key - for back door
- 19 - Mills cashbox locking plate
- 20 - Mills lock and key - for back door
- 21 - Mint vendor door lock and key
- 22 - FOK lock and key - for back door
- 23 - Cam lock and key - for back door
- 24 - Front loading lock for jackpot - Mills original
- 354 - Q.T. back door lock and key
- 355 - Q.T. front door lock and key
- 356 - Vest Pocket back door lock and key
- 357 - Pace back door lock and key - original

LOCKING PLATES

- 132 - Mills locking plate
- (Mills original & repro. locks require a locking plate)
- 358 - Watling Penny Gumball top locking plate
 - 228 - Rockola front locking door

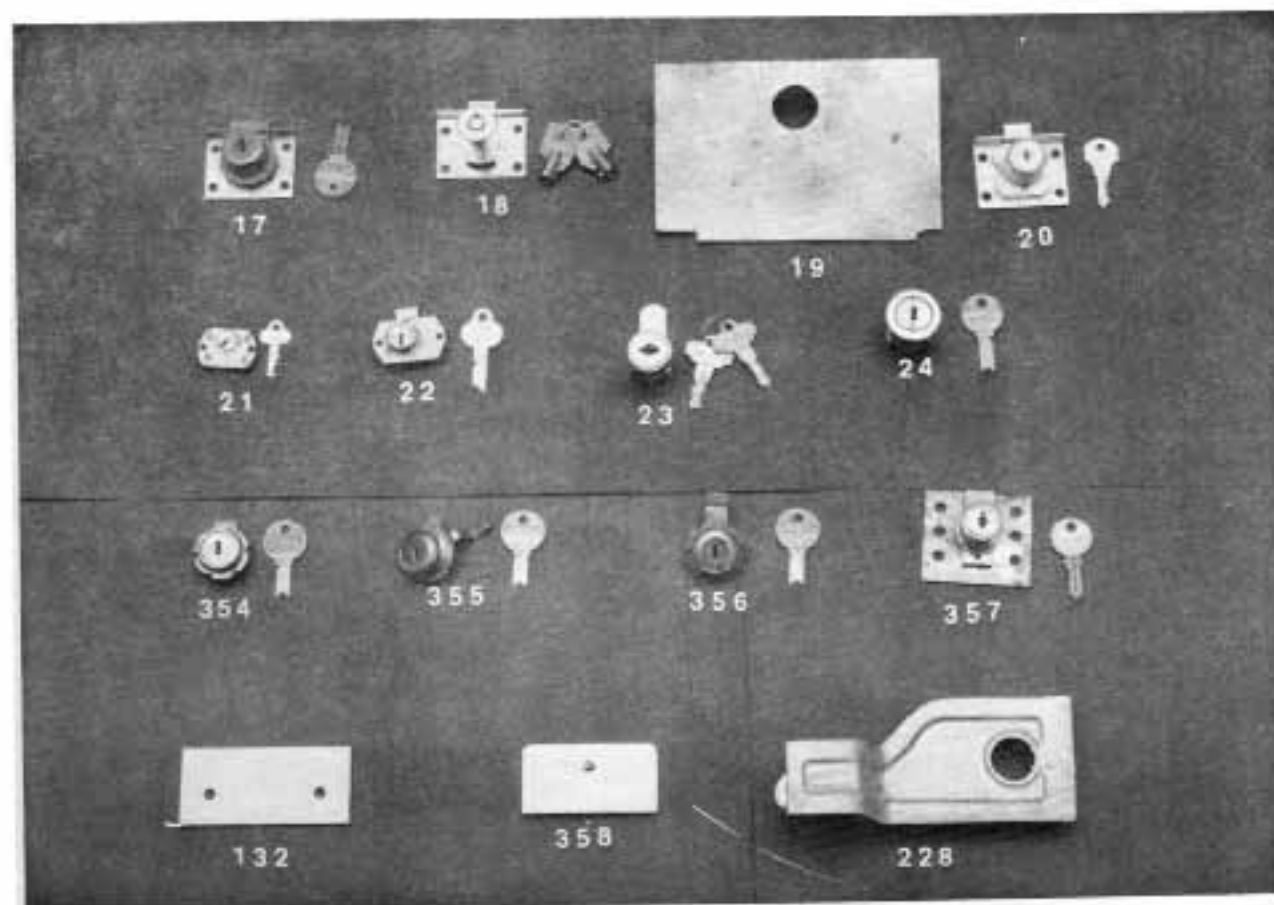

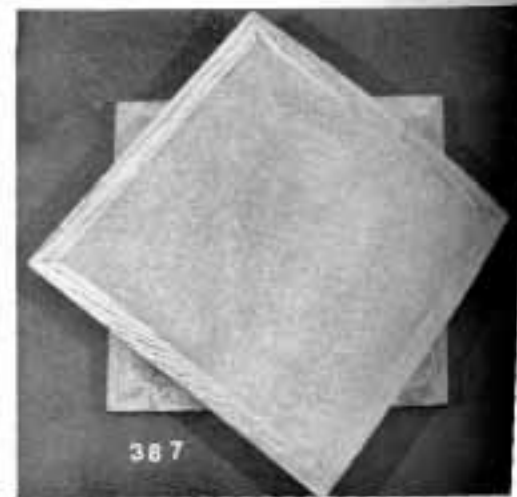
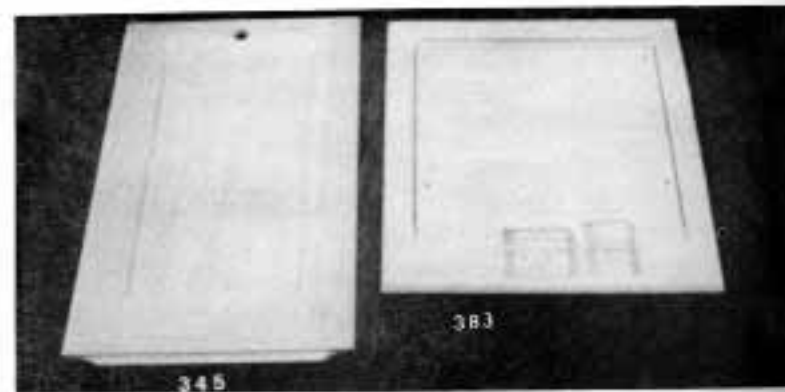
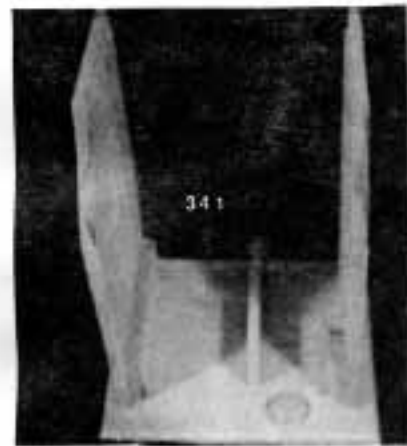
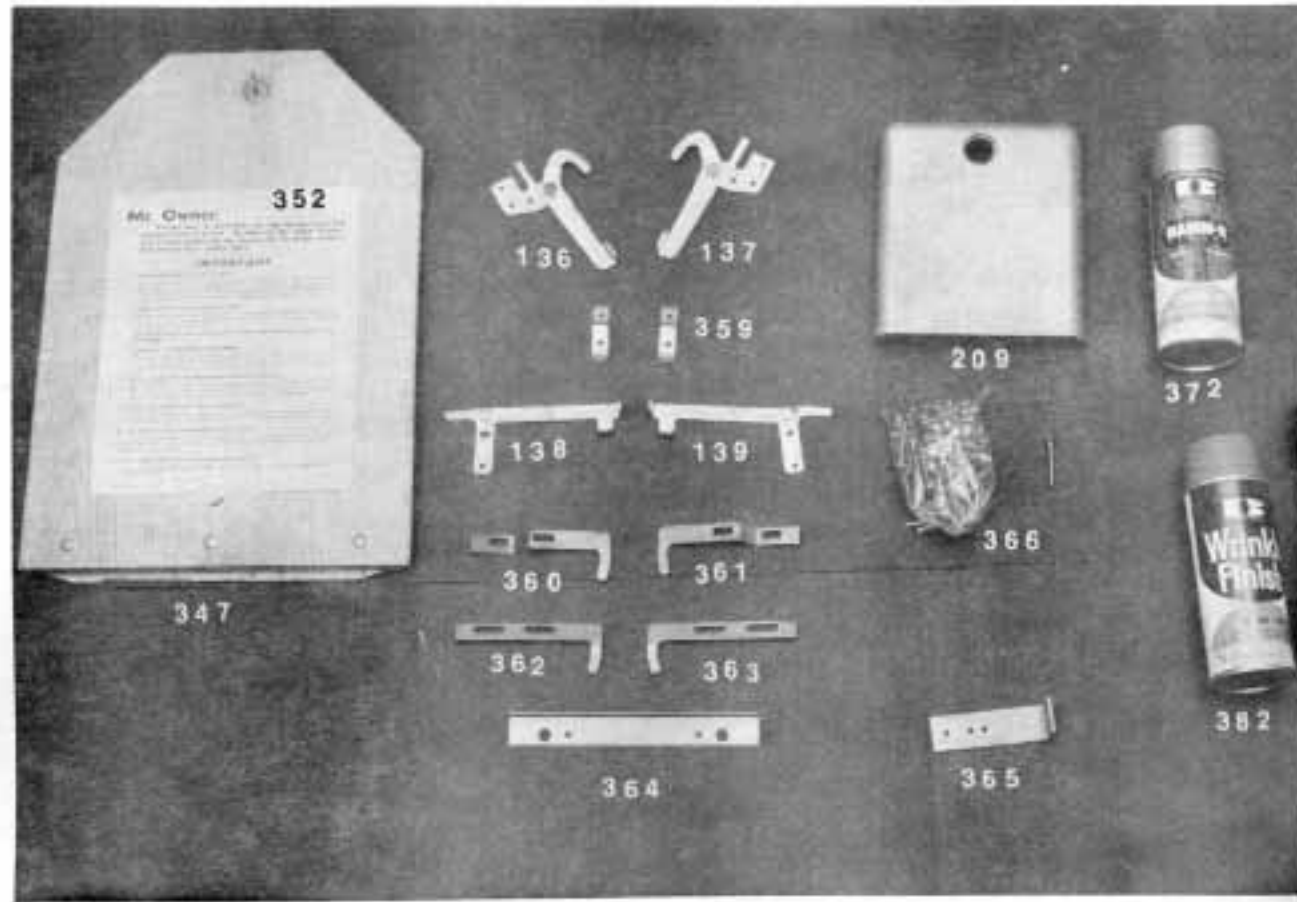

BACK DOORS

- 209 - Vest Pocket
- 331 - Mills original
- 332 - Jennings original
- 333 - Mills - uses original lock or repro. Mills lock
- 334 - Jennings
- 335 - Watling
- 336 - Q.T.
- 337 - Caille
- 338 - Jennings Duchess
- 339 - Pace Bantam
- 345 - Early Mills wooden door
- 347 - Little Duke wooden door
- 348 - Mills - uses cam lock
- 349 - Mills FOK - uses original Mills lock
- 350 - Mills FOK- uses cam lock
- 351 - Pace

HAMMER FINISH

- 367 - Blue
- 368 - Not available
- 369 - Charcoal Grey
- 370 - Silver
- 371 - Not Available
- 372 - Green

PAINT

WRINKLE FINISH

- 373 - British Brown
- 374 - Celestial Blue
- 375 - French Grey
- 376 - Not Available
- 377 - Not Available
- 378 - Not Available
- 379 - Not Available
- 380 - Not Available
- 381 - Jet Black
- 382 - Not Available

CABINET HARDWARE

- 136 - Mills left hood latch
- 137 - Mills right hood latch
- 138 - Mills mechanism hold down bracket - left side
- 139 - Mills mechanism hold down bracket- right side
- 359 - Mills mechanism clamp retainer
- 360 - Early Jennings mechanism latch - left
- 361 - Early Jennings mechanism latch - right
- 362 - Jennings hood latch - left
- 363 - Jennings hood latch - right
- 364 - Mills cabinet side top guard
- 365 - Hi-Top front casting mounting bracket
- 366 - Carriage bolts - chrome plated

CABINETS

- 340 - Black Cherry
 - 341 - War Eagle
 - 342 - Blue Front
 - 343 - Hi-Top
 - 344 - Mills Gooseneck
- All cabinets are solid oak and unfinished. Cabinets in other styles are available on request.
- 352 - Mills back door instruction sheet
 - 353 - Watling back door instruction sheet (not pictured)
 - 383 - Base of cabinet-specify machine
 - 384 - Poinsetta Style Stencil
 - 385 - Roman Head Style Stencil
 - 386 - FOK Style Stencil
 - 387 - Wood swivel base-great for turning your machine to adjust or play it.

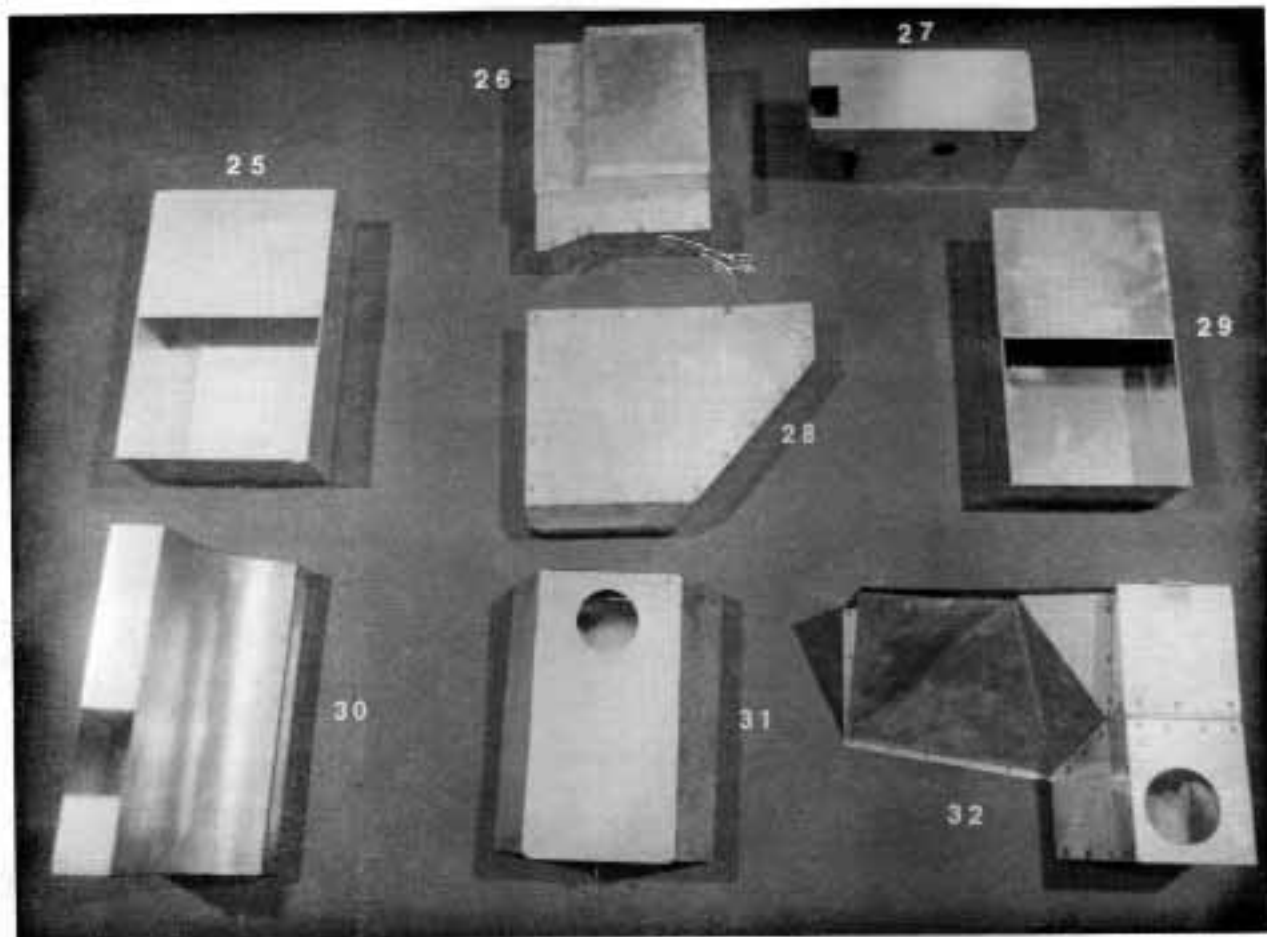

CASHBOXES

25 - Mills

26 - Columbia

27 - Vest Pocket

28 - Columbia

29 - Watling

30 - Upright

31 - Caille

32 - Little Duke

33 - Jennings Peacock

34 - Jennings Gooseneck

35 - Jennings Duchess

36 - Jennings Today Vendor

37 - Escalator overflow cup (slug cup)

38 - Jennings Standard Chief

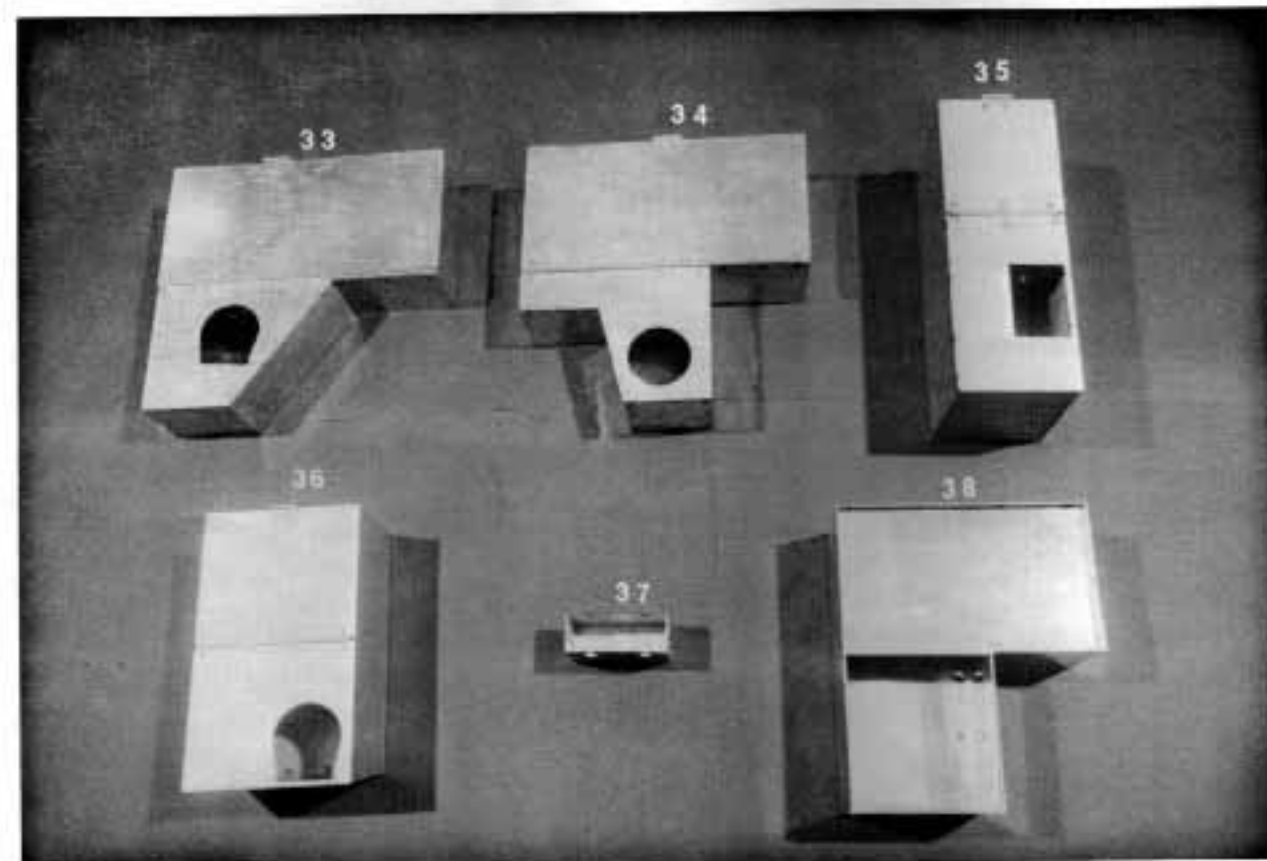

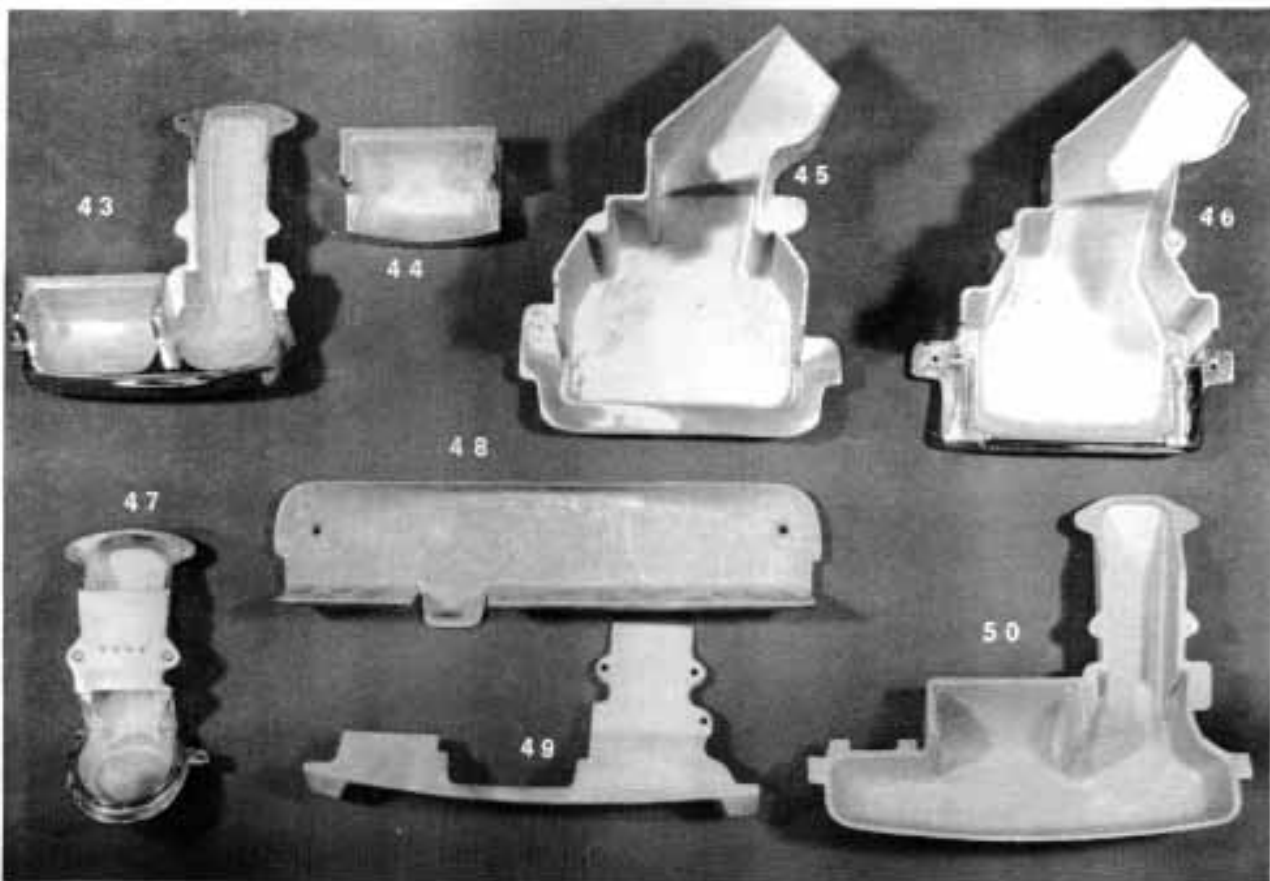
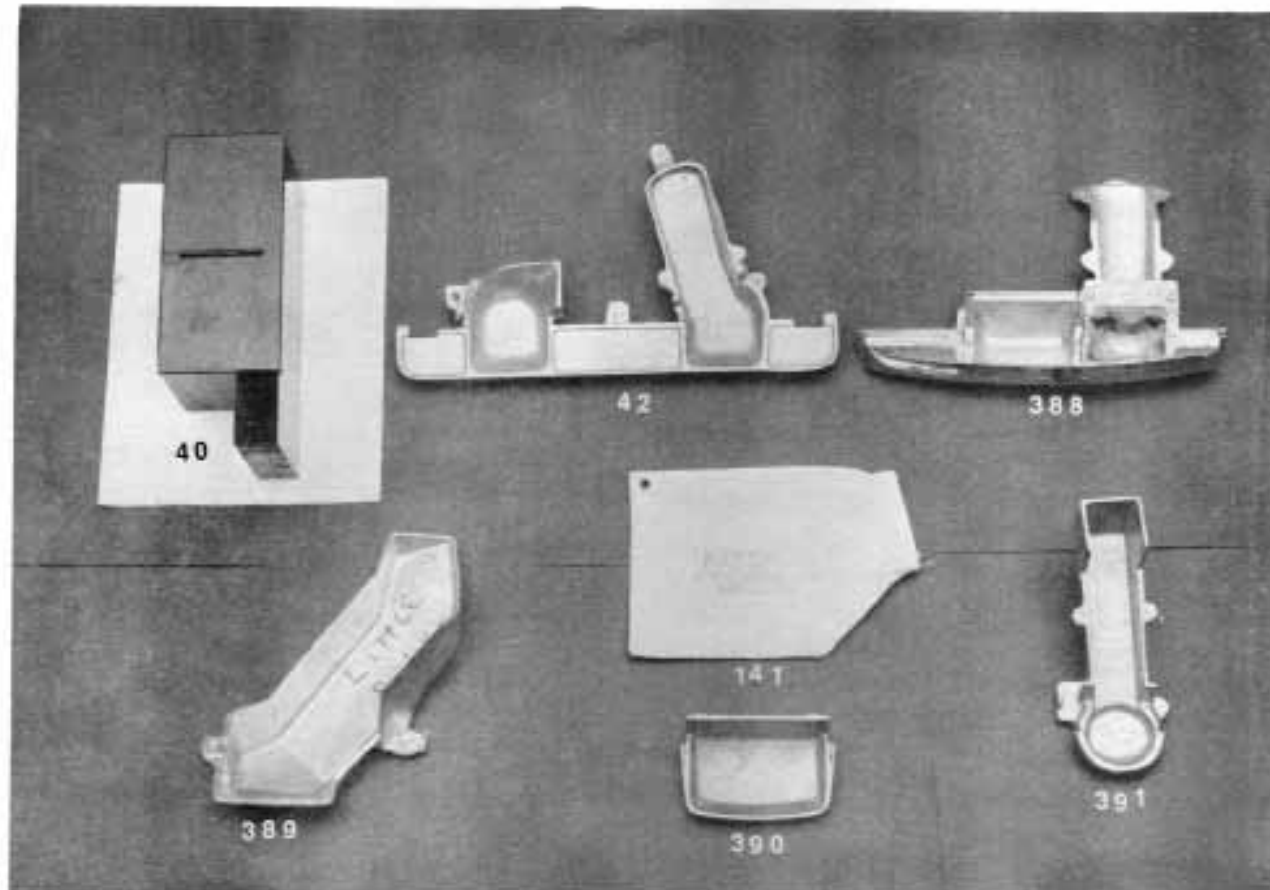

CASHBOXES

39 - Buckley (not pictured)

40 - Baby Watling

MONEY BOWLS (CHROMED)

42 - Baby Watling

43 - Black Cherry

44 - War Eagle - for jackpot
Blue Front
Castle Front
Bursting Cherry

45 - Jennings Standard Chief

46 - Jennings Sun Chief

47 - Mills Gooseneck, Bursting Cherry, Blue Front, War Eagle, Castle Front

48 - Watling money tray

48 - Watling money tray

50 - Hi-Top
Silver Palace

141 - Pace money bag

388 - Extrabelle

389 - Little Duke

390 - Q.T. jackpot cup

391 - Q.T. money bowl

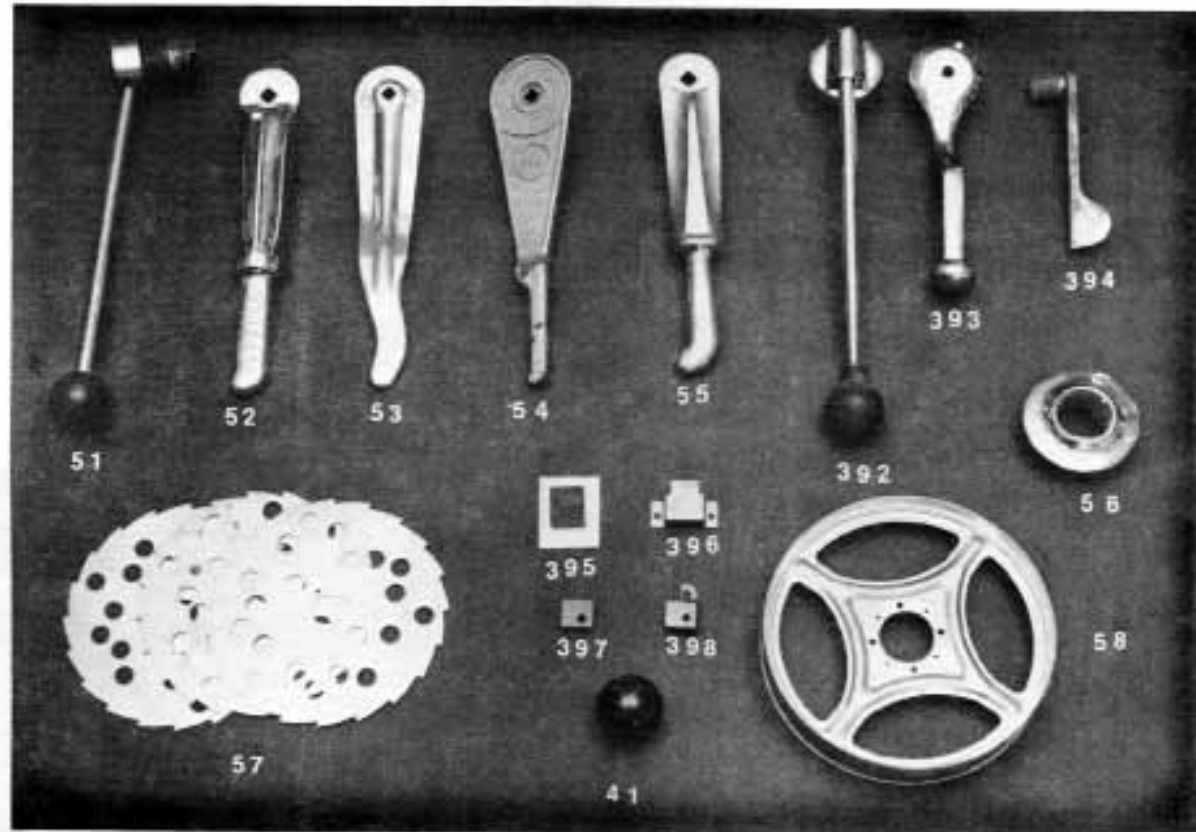

HANDLES (CHROMED)

- 51 - Hi-Top- rod & ball (Club)
- 52 - Hi-Top- (Standard)
- 53 - Gooseneck
- 54 - Watling Blue Seal
- 55 - Black Cherry - sword type
- 392 - Early Jennings
- 393 - Little Duke
- 394 - Q.T.

MISCELLANEOUS

- 41 - Handle Ball
- 56 - Handle hub
- 57 - Three reel disc. set, SP or CH
- 58 - Mills reel tin
- 133 - Mills pulldown arm
- 134 - Mills overflow tube 1¢, 5¢, 10¢, 25¢, 50¢
- 135 - False jackpot
- 187 - Handle starting lever
- 188 - Handle starting lever bracket
- 189 - Piston operating lever
- 190 - Piston operating lever support
- 191 - Pump
- 192 - Slotless award card bolts
- 193 - Piston operating lever
- 194 - Back bonnet strap
- 195 - Rivets for reel tins, escalators - 1 pound
- 208 - Twenty stop star wheel
- 395 - Rubber bumper
- 396 - Rubber bumper retainer
- 397 - Locking lever bracket bumper
- 398 - Locking lever bracket retainer
- 399 - Jackpot felt washer
- 400 - Cabinet washer
- 401 - Mills bonus linkage
- 402 - Mills bonus linkage
- 403 - Mills bonus linkage
- 404 - Vest Pocket rubber feet

SPRINGS

Mills

- 196 - Reel stop
- 197 - Escalator advance bar
- 198 - Master slide
- 199 - Slide
- 200 - Safety Slide
- 201 - Escalator locking bar
- 202 - Pulldown arm
- 203 - Handle return
- 204 - Operating bar retainer
- 205 - Upper finger
- 206 - Lower finger
- 207 - Escalator coil

Jennings

- 405 - Upper finger
- 406 - Lower finger

Watling

- 407 - Lower finger
- 408 - Upper finger
- 409 - First slide
- 410 - Second slide
- 411 - Third slide
- 412 - Fourth slide
- 413 - Jackpot slide



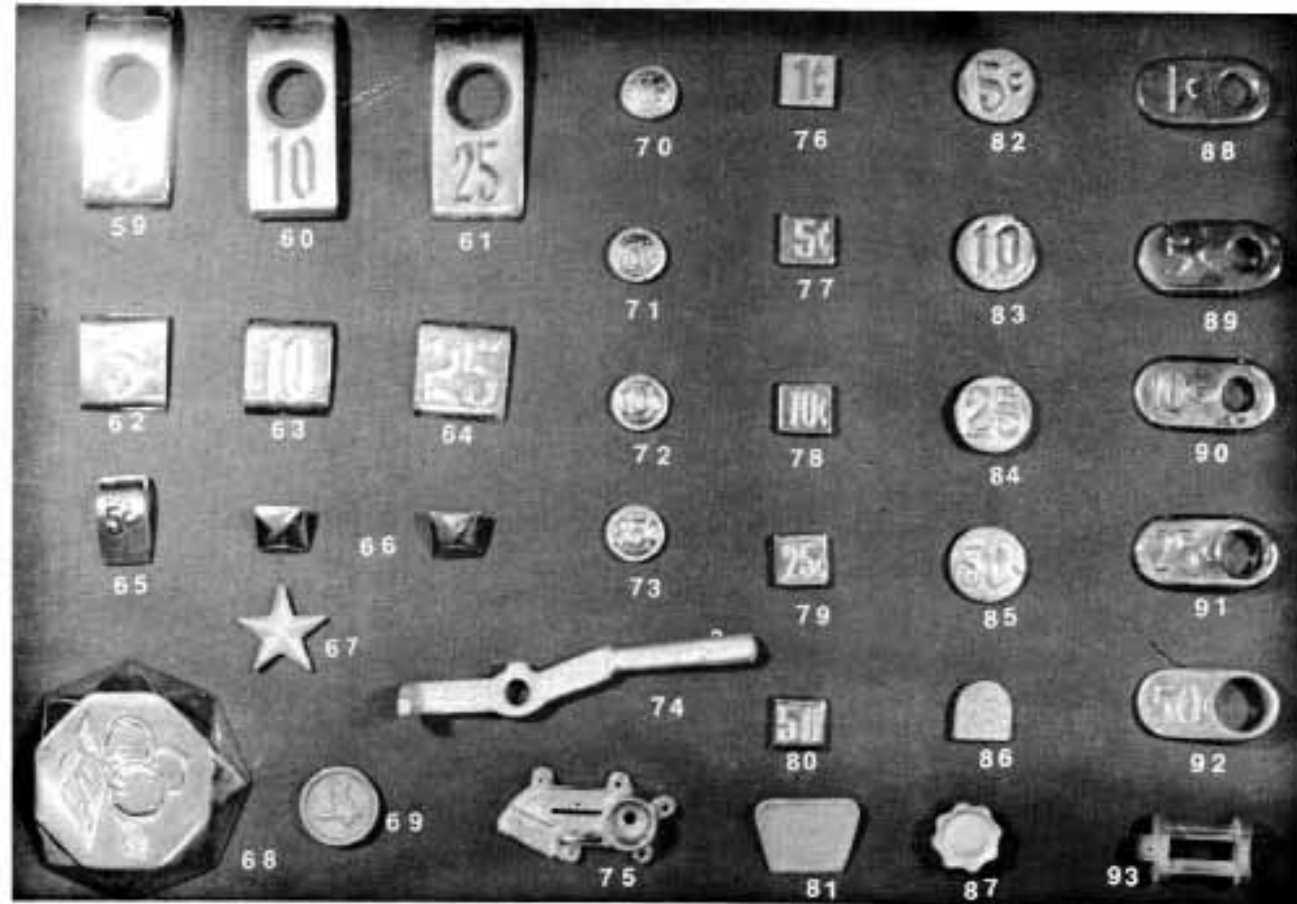

DENOMINATOR BUTTONS & MISC.

- 59 - Mills Bonus - 5¢
- 60 - Mills Bonus - 10¢
- 61 - Mills Bonus - 25¢
- 62 - Mills Console - 5¢
- 63 - Mills Console - 10¢
- 64 - Mills Console - 25¢
- 65 - QT 5¢ (1¢ available)
- 66 - Diamond-unplated or plated
- 67 - Jennings star -unplated or plated
- 68 - Cherry Burst for Bursting Cherry
- 69 - Owl button
- 70 - Mills round - 1¢
- 71 - Mills round- 5¢
- 72 - Mills round - 10¢
- 73 - Mills round- 25¢
- 74 - Watling cocking tool
- 75 - Jennings coin entry -5¢,10¢,25¢,50¢
- 76 - Mills square - 1¢
- 77 - Mills square - 5¢
- 78 - Mills square - 10¢
- 79 - Mills square - 25¢
- 80 - Mills square - 50¢
- 81 - Side vendor cover plate
- 82 - Hi-Top round - 5¢
- 83 - Hi-Top round - 10¢
- 84 - Hi-Top round - 25¢
- 85 - Hi-Top round - 50¢
- 86 - Horsehead bonus -5¢,10¢,25¢
- 87 - Vendor knob
- 88 - Black Cherry - 1¢
- 89 - Black Cherry - 5¢
- 90 - Black Cherry - 10¢
- 91 - Black Cherry - 25¢
- 92 - Black Cherry - 50¢
- 93 - Mint vendor roller
- 94 - Mills Name Plate
- 95 - Hi-Top plate - 5¢
- 96 - Hi-Top plate - 10¢
- 97 - Hi-Top plate - 25¢

HARDWARE

- 98 - Hi-Top Money Bowl Apron
- 99 - Bumper for Hi-Top
- 100 - Right wing
- 101 - Left wing
- 102 - Hi-Top Jewel Bell jackpot cover plate
- 103 - Hi-Top Special Award "777" - \$10
- 104 - Hi-Top arrow Window
- 105 - Hi-Top Special Award "777" - \$20
- 106 - Hi-Top Special Award "777" - \$50
- 107 - Hi-Top Special Award "777" - \$100
- 414 - Hi-Top Special Award "777" - \$200
- 218 - Golden Falls - unplated
- 226 - Cherry cluster - 3 cherries
- 227 - Cherry cluster - 2 cherries
- 317 - Girl only - specify right or left
- 318 - Decal- "Golden Girl"
- 319 - Nugget
- 320 - Golden Nugget set - brass plated - includes 2 girls, 2 nuggets & decals
- 415 - Watling Gold Award Eagle
- 416 - Watling Eagle
- 417 - Watling Eagle
- 418 - Horsehead Bonus horse - unplated
- 419 - Jennings emblem with bugle

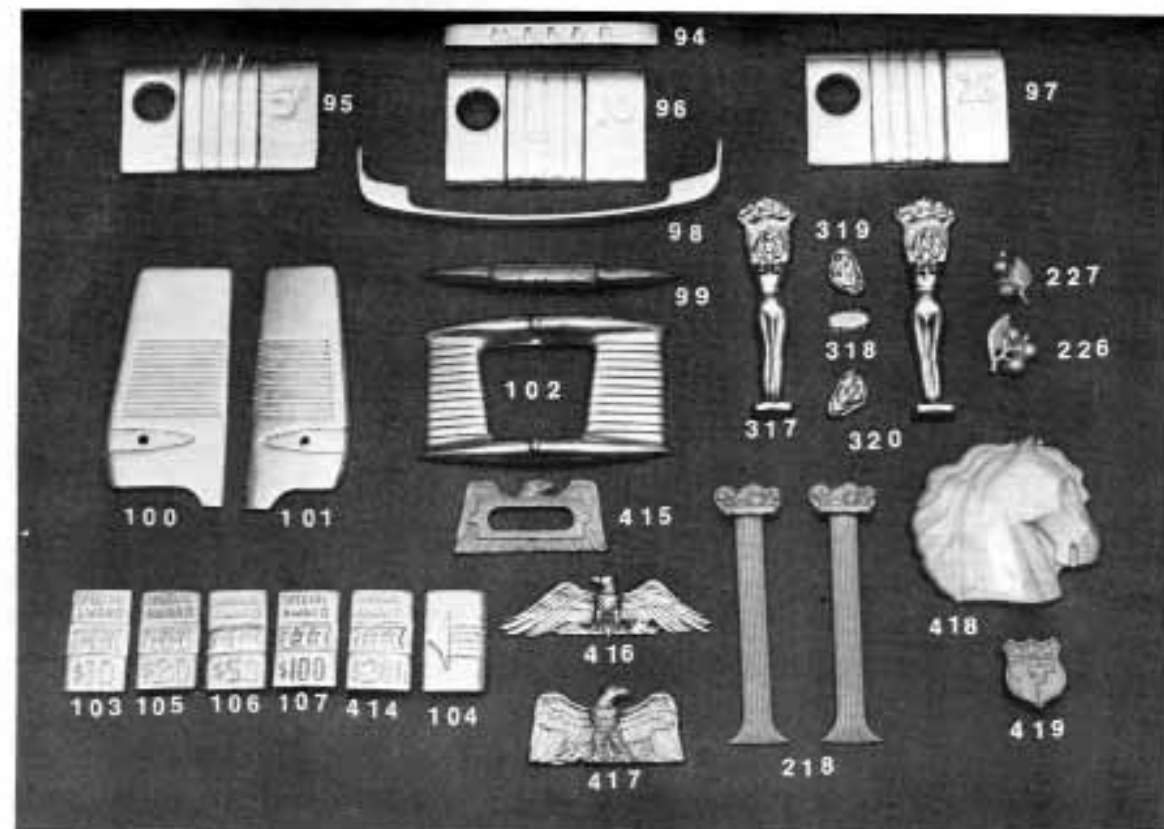

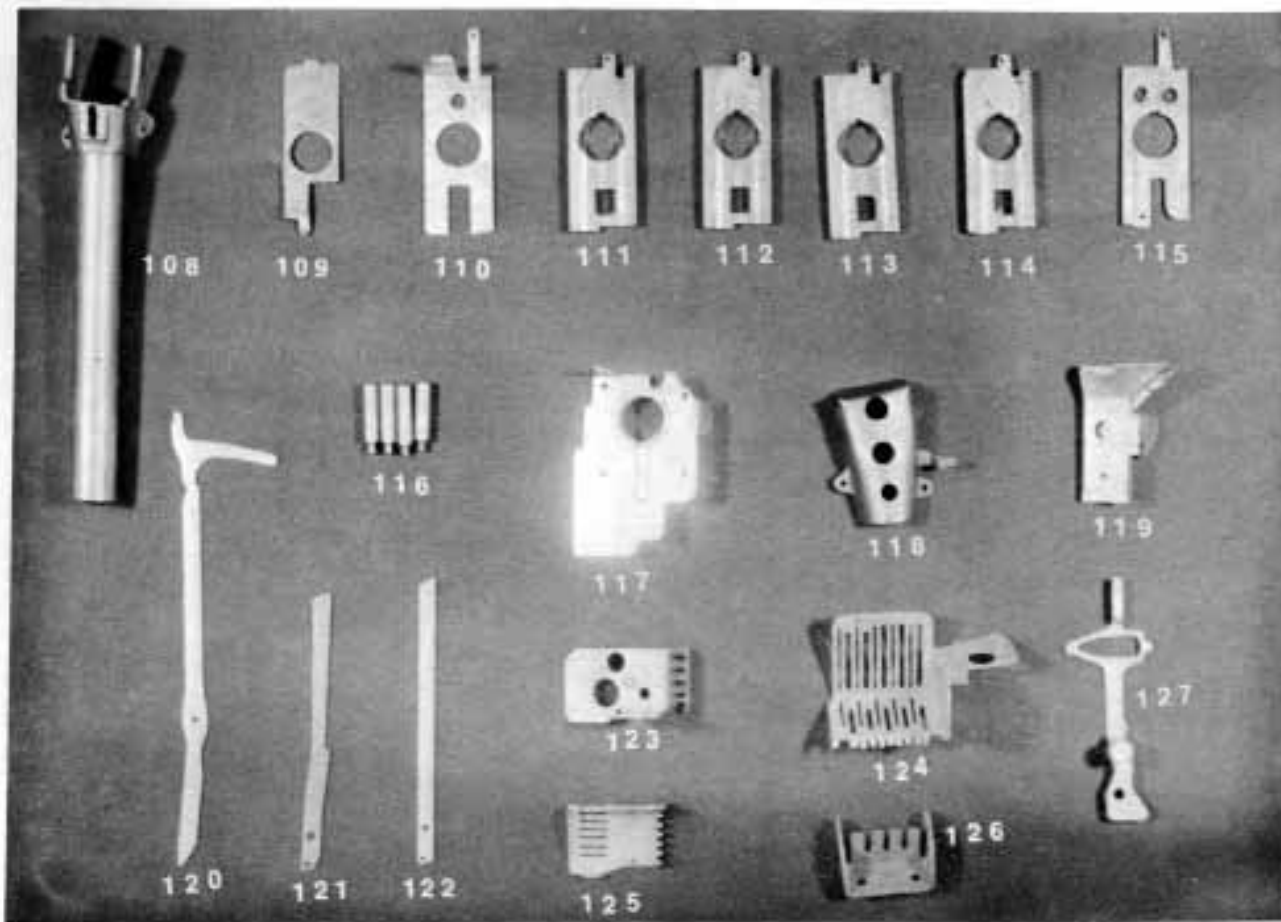

SLIDES & RELATED PARTS

- 108 - Coin tube - 1¢,5¢,10¢,25¢,50¢
- 109 - Safety slide - 1¢,5¢,10¢,25¢,50¢
- 110 - Master slide
- 111 - Two pay slide
- 112 - Five pay slide
- 113 - Four pay slide
- 114 - Four pay slide
- 115 - Two pay top slide
- 116 - Post- 1¢,5¢,10¢,25¢,50¢
- 117 - Slide cover
- 118 - Coin tube splash cover
- 119 - Lower coin chute
- 120 - Upper finger blank
- 121 - Horizontal bottom payout lever
- 122 - Regular horizontal payout lever
- 123 - Horizontal payout lever guide
- 124 - Parallel payout lever guide
- 125 - Horizontal payout lever bracket
- 126 - Parallel lower payout bracket
- 127 - Safety slide holding lever
- 128 - Set of 1¢ slides
- 129 - Set of 5¢ slides
- 130 - Set of 10¢ slides
- 131 - Set of 25¢ slides

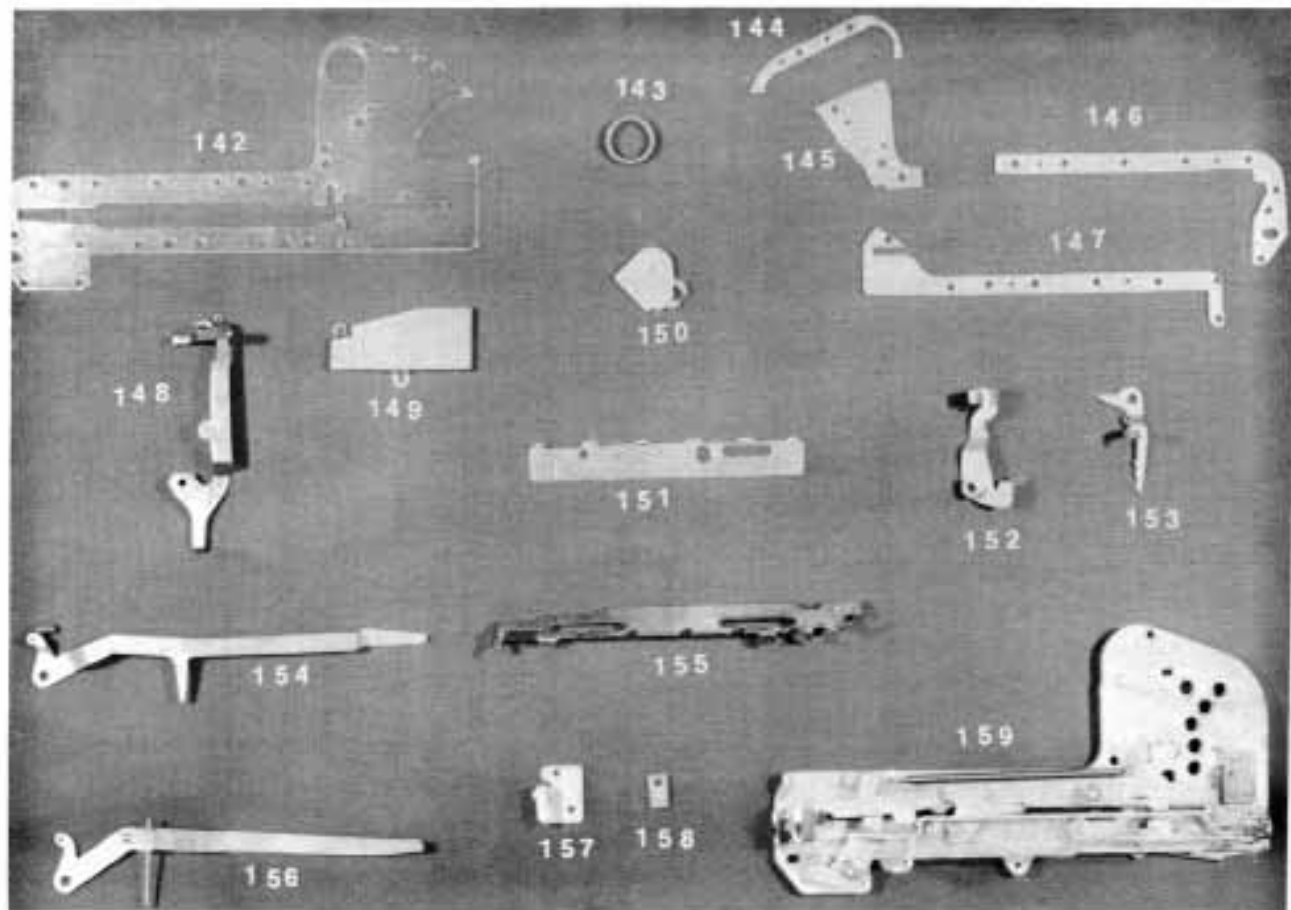

ESCALATOR PARTS

- 142 - Front plate
- 143 - Hi-Top ring
- 144 - Top spacer
- 145 - Middle spacer
- 146 - End spacer
- 147 - Bottom spacer
- 148 - Coin release bar
- 149 - Slug chute cover
- 150 - Magnet and cover
- 151 - Coin holding bar
- 152 - Coin advance bar lever
- 153 - Coin advance bar locking lever
- 154 - Coin detector arm
- 155 - Coin advance bar
- 156 - Coin detector lever
- 157 - Bracket for leather bumper
- 158 - Leather bumper
- 159 - Complete escalator- 1¢,5¢,10¢,25¢

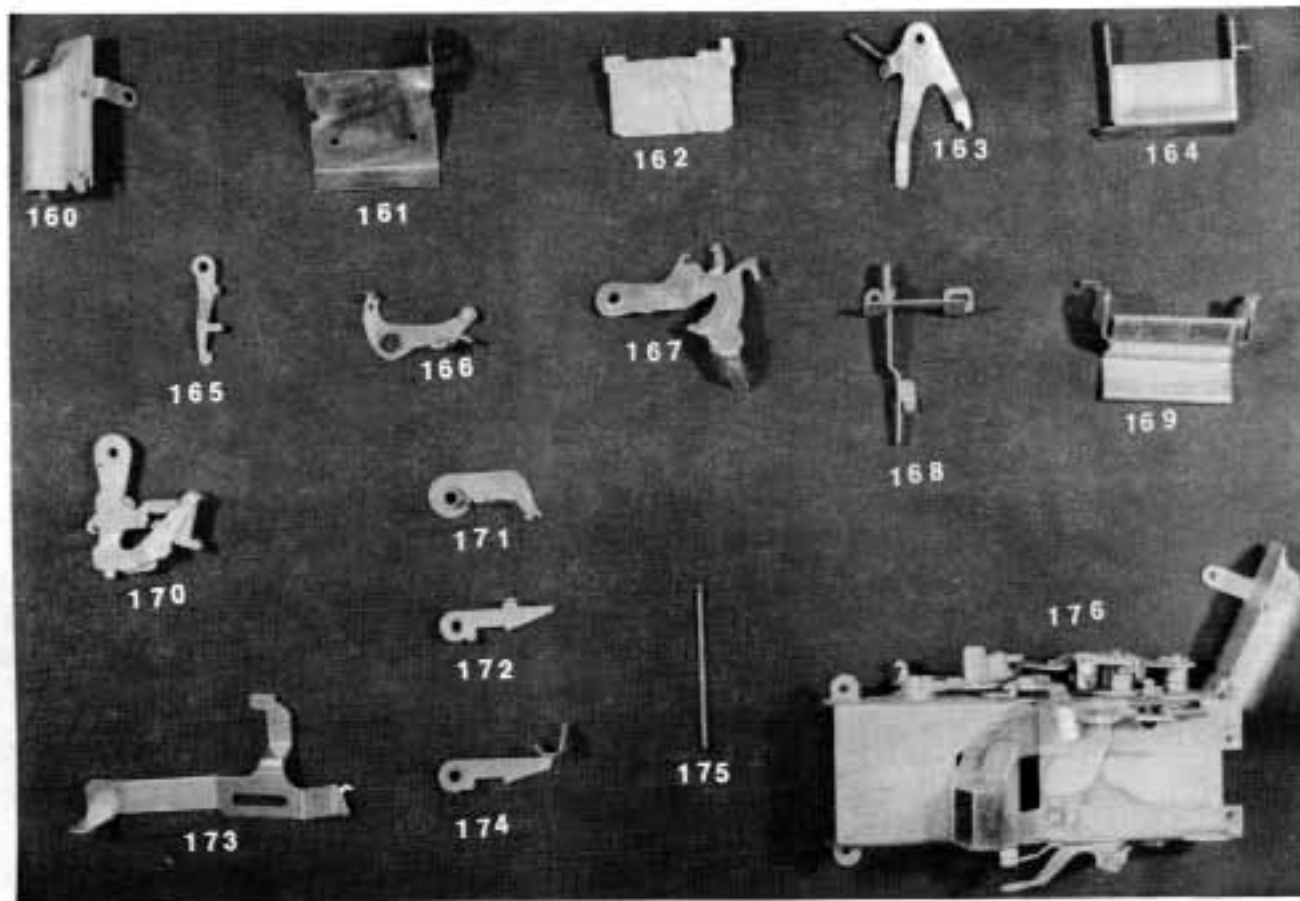

JACKPOT PARTS

- 160 - Chute
- 161 - Trap door
- 162 - Coin deflector
- 163 - Early jackpot locking bar
- 164 - Reserve retainer
- 165 - Reserve retainer locking latch
- 166 - Jackpot dump lever
- 167 - Safety locking lever
- 168 - Jackpot trip lever
- 169 - Jackpot trap door
- 170 - Reserve operating lever
- 171 - Reserve locking lever
- 172 - Locking lever
- 173 - Push bar
- 174 - Jackpot locking lever old style
- 175 - Door shaft
- 176 - Complete jackpot- 1¢,5¢,10¢,25¢
Specify Mills or Jennings

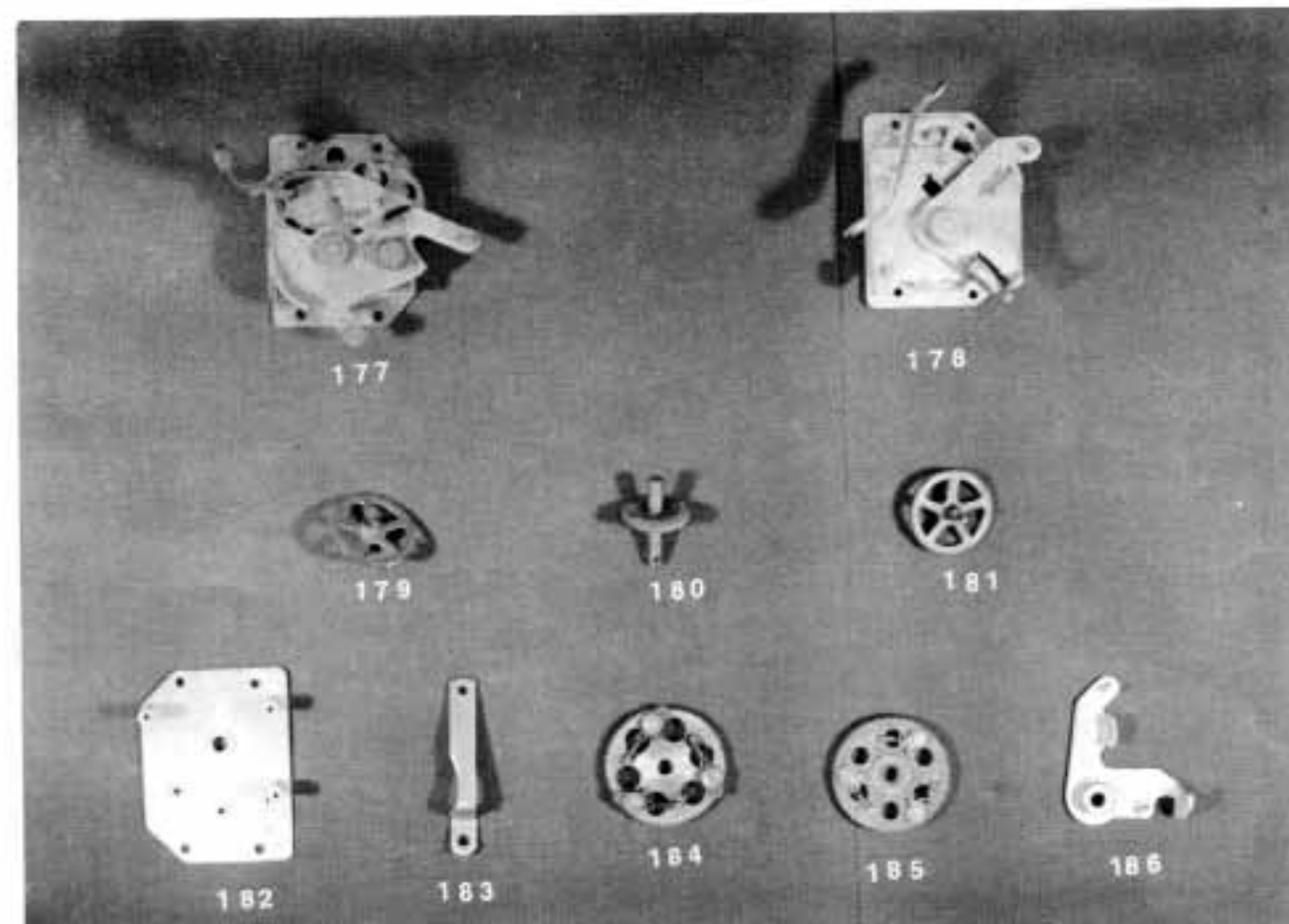

CLOCKS

- 177 - Jennings clock
- 178 - Mills clock
- 179 - Idler gear
- 180 - Ratchet & shaft
- 181 - Clock fan gear
- 182 - Bottom clock plate
- 183 - Reel timing connecting link
- 184 - Jennings bow gear
- 185 - Mills bow gear
- 186 - Clock arm without roller

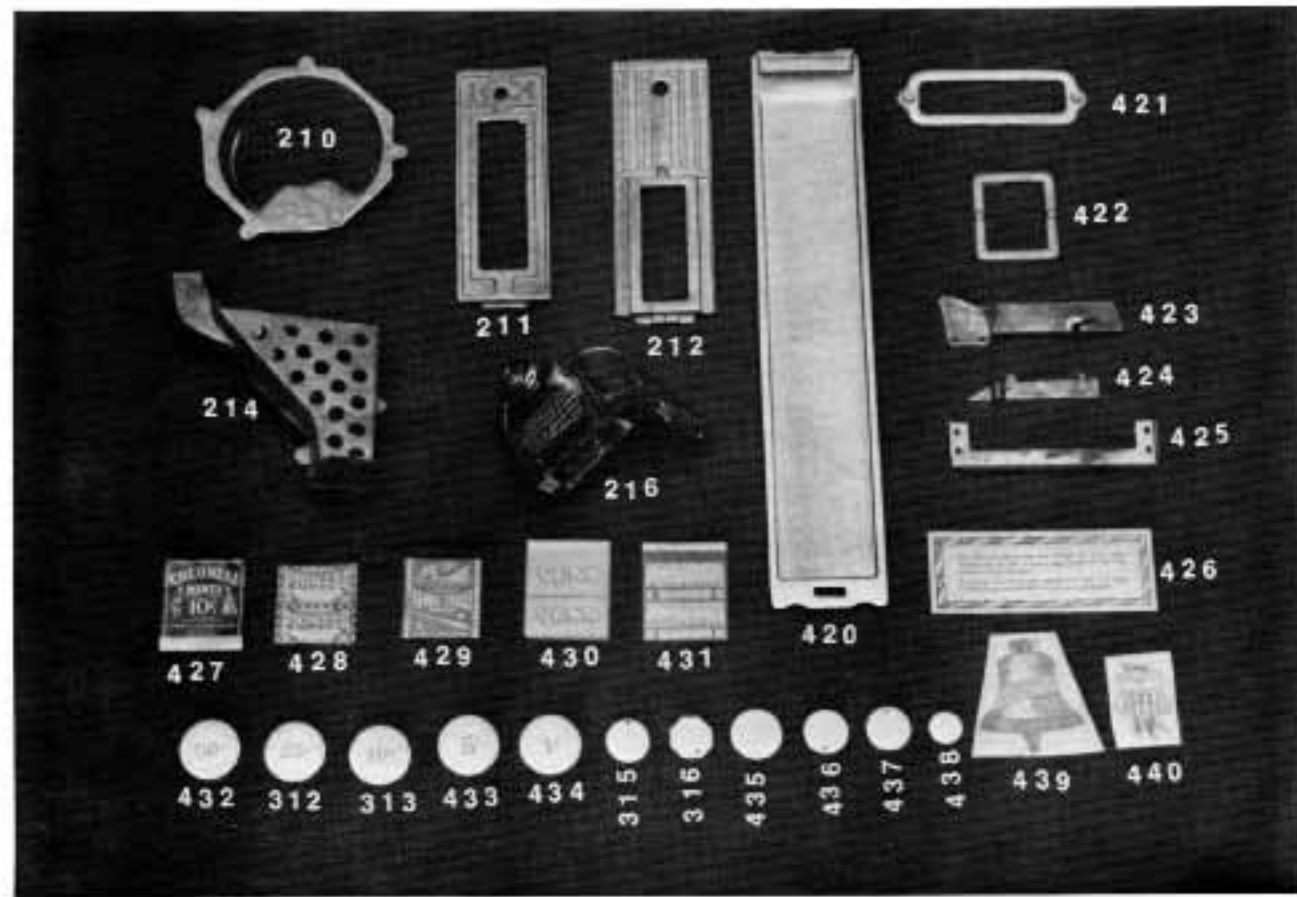

MISCELLANEOUS

- 210 - Rol-A-Top glass frame holder
- 211 - Watling mint vendor door
- 212 - Jennings mint vendor door
- 214 - Watling money funnel
- 216 - Little Duke coin head
- 222 - Jackpot plate
- 312 - Watling Rol-A-Top denominator badge- 25¢
- 313 - Watling Rol-A-Top denominator badge- 10¢
- 315 - Watling Gold Seal Award token- brass plated
- 316 - Mills octagon "777" Award token- brass plated
- 420 - Side vendor back door- unplated
- 421 - Jennings award card frame
- 422 - Pace award card frame
- 423 - Q.T. jackpot loading chute
- 424 - Q.T. jackpot divider
- 425 - Q.T. jackpot lower coverplate
- 426 - Marquee award card 2-1/2 x 6-1/2
- 427 - Colonial Mint wrapper
- 428 - Pioneer Mint wrapper
- 429 - Strike Three Mint wrapper
- 430 - Vens Mint wrapper (blue, green, red}
- 431 - Wintergeeen Mint wrapper
- 432 - Rol-A-Top denominator badge - 50¢
- 433 - Rol-A-Top denominator badge- 5¢
- 434 - Rol-A-Top denominator badge - 1¢
- 435 - Superior Gold Award token - horse pictured
- 436 - Mills Gold Award token - pitcher pictured
- 437 - Prosperity Award token
- 438 - Small trade stimulator token (star with five in it }
- 439 - No longer available
- 440 - Early Pace decal

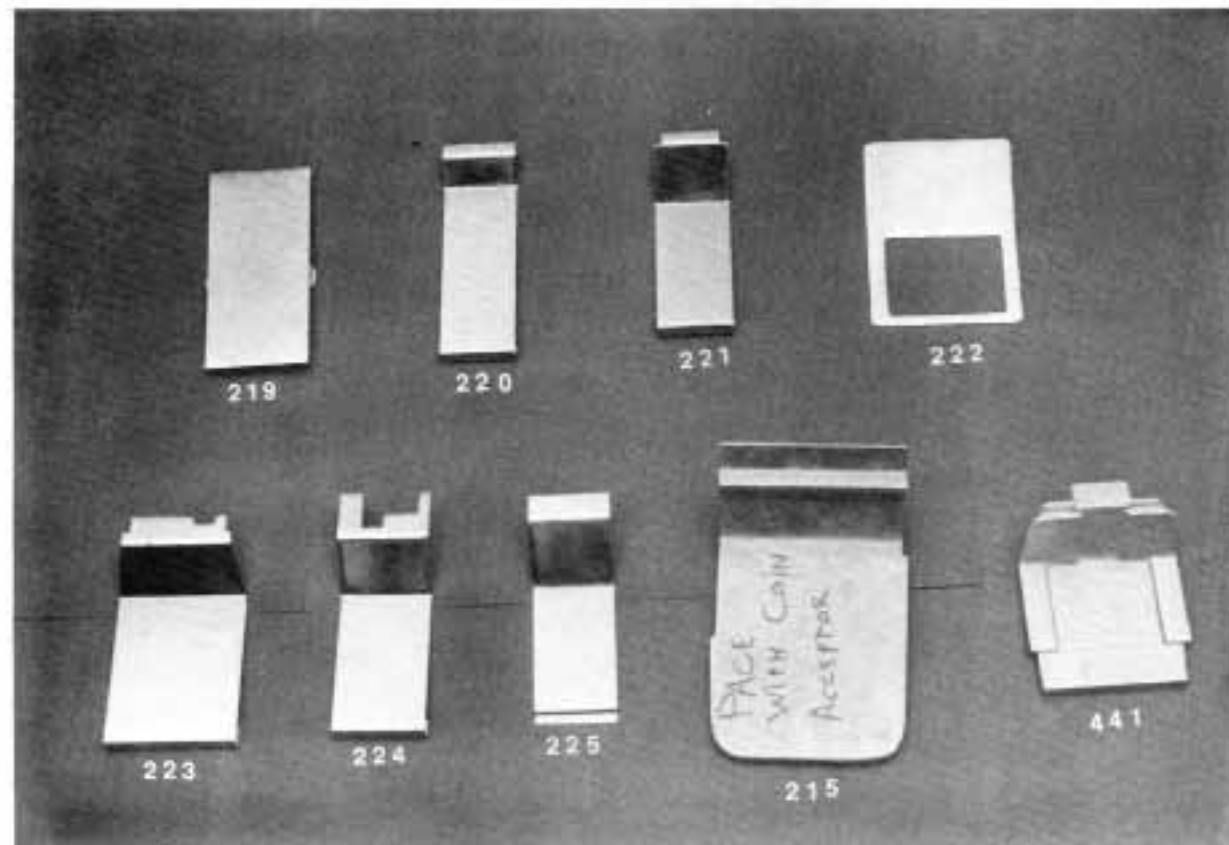

BACK LIPS

- 215 - Pace back lip for coin acceptor
- 219 - Pace Bantam
- 220 - Watling
- 221 - Mills 2"
- 223 - Pace
- 224 - Mills 2-1/4"
- 225 - Jennings
- 441 - Caille Doughboy
- 459 - Jennings Victoria - not pictured

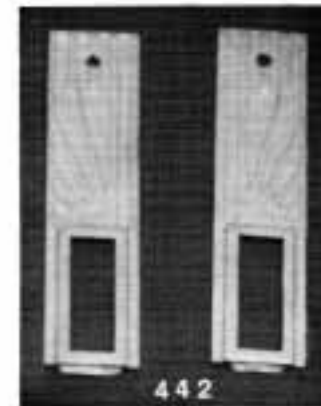

- 442 - Early Jennings vendor covers
- 443 - Q.T. jackpot window frame

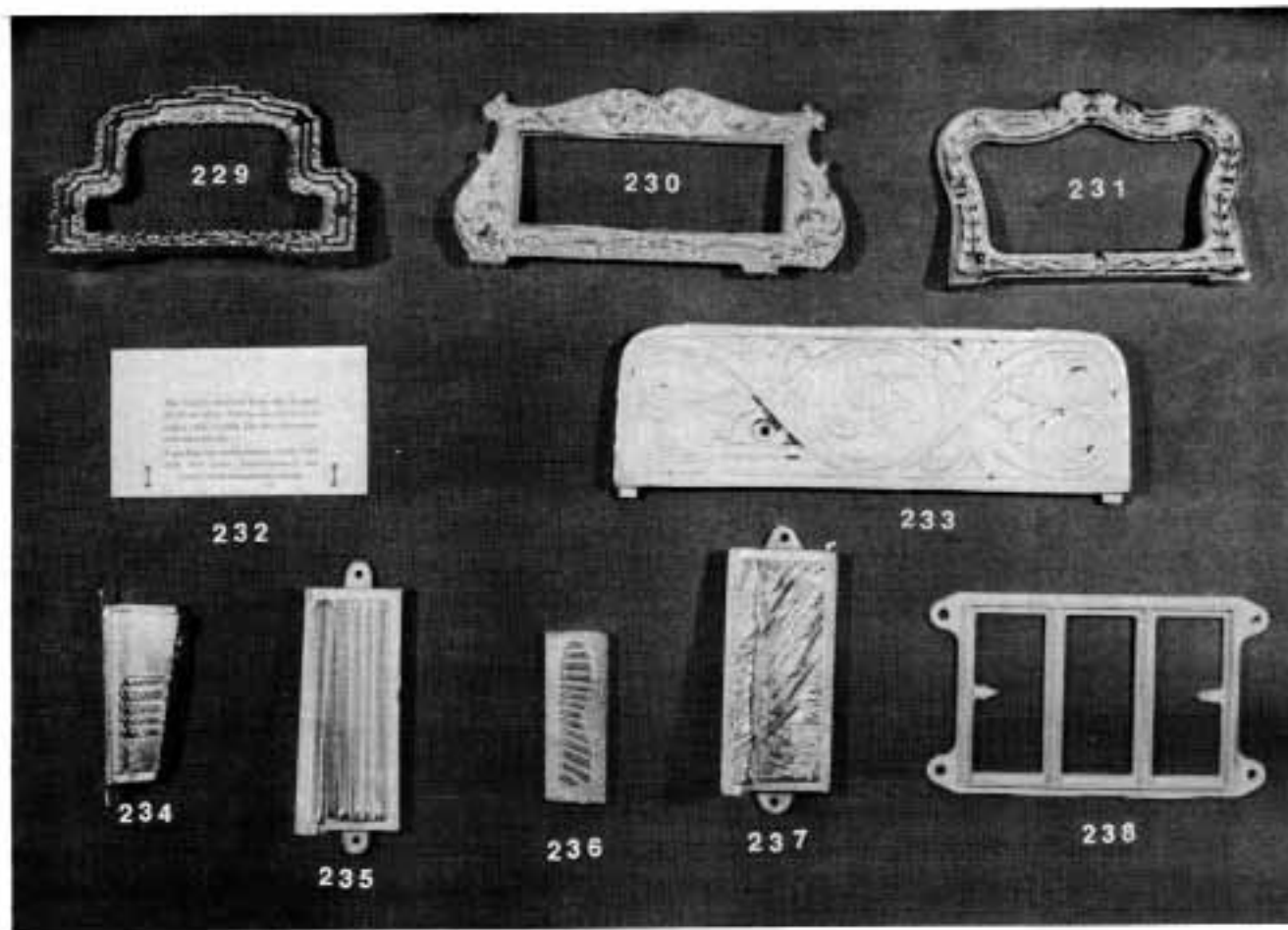

MISCELLANEOUS

- 229 - Mills marquee - 2-3/4" x 5-1/2" (inside)
- 230 - Mills marquee
- 231 - Mills marquee - 3" x 5-1/2" (inside)
- 232 - Mills marquee card - 3-1/2" x 6"
- 233 - Caille back plate
- 234 - Bursting Cherry jackpot casting plate
- 235 - Skyscraper jackpot casting plate
- 236 - Bursting Cherry Gold Award casting plate
- 237 - War Eagle jackpot casting plate
- 238 - Escalator window frame

AWARD CARD FRAMES (CHROMED)

- 239 - Cast iron Operator's Bell
- 240 - Bursting Cherry
- 241 - FOK
- 242 - Mills Poinsetta
- 243 - War Eagle
- 244 - Wolf Head
- 245 - Q.T.
- 246 - FOK
- 247 - Jackpot spacer
- 248 - Little Duke
- 249 - Pace (ears on top & bottom)
- 250 - Escalator window frame
- 251 - Short FOK
- 252 - Pace (ears on side)
- 253 - Mills Extraordinary

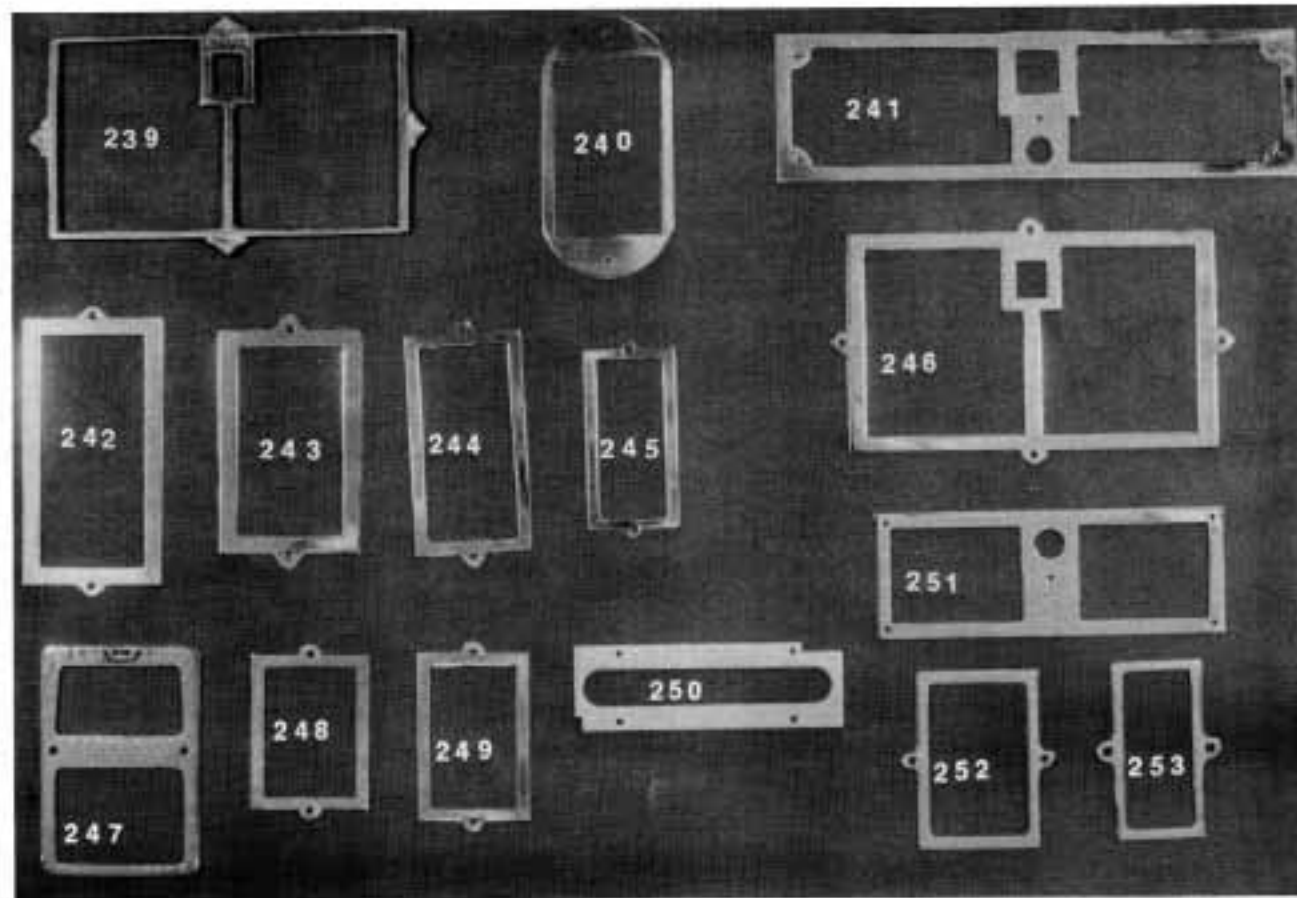

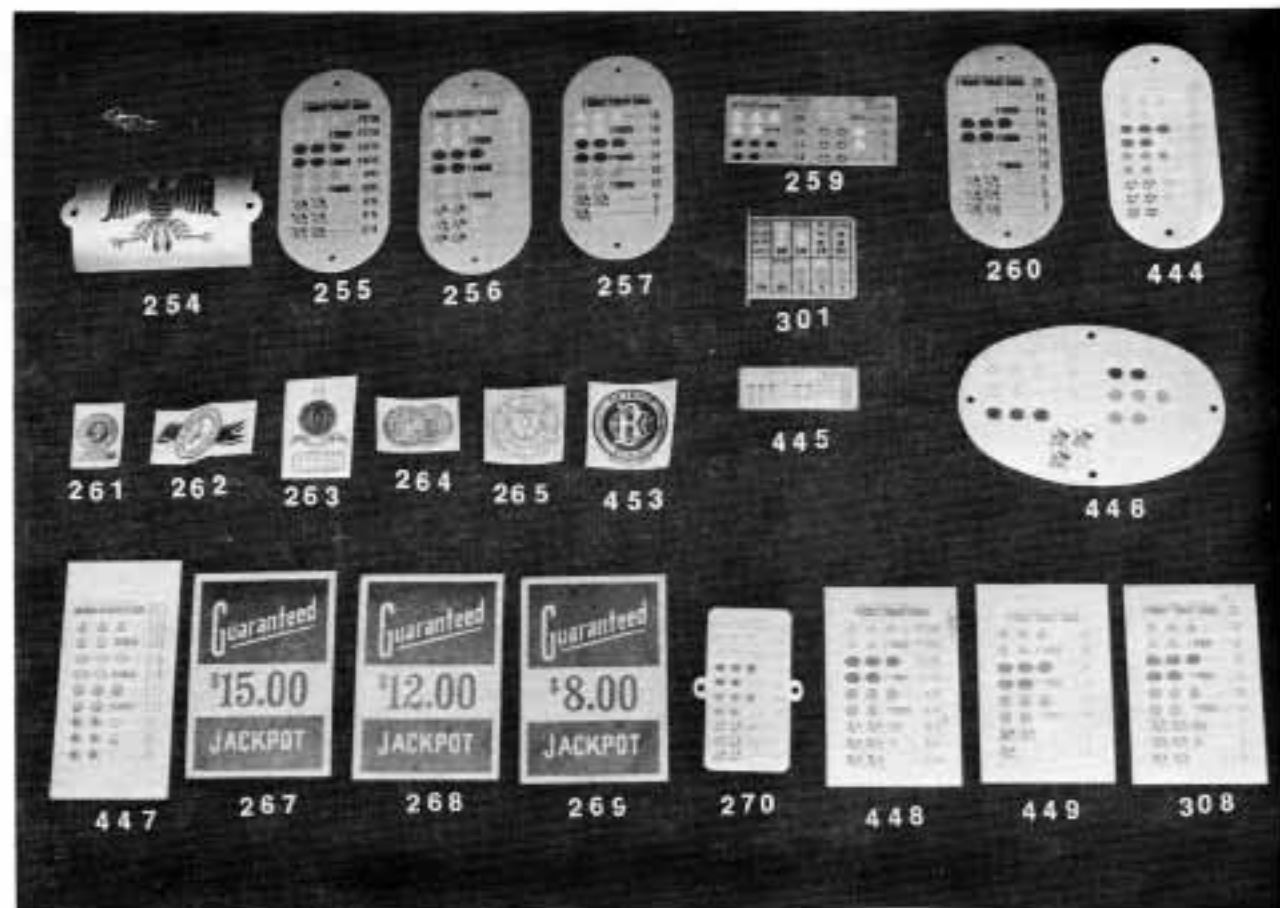

AWARD CARDS

- 254 - Extraordinary Eagle
- 255 - Bursting Cherry Variance card
- 256 - Bonus 3-5
- 257 - Mills oval 2-5
- 259 - Pace card 3-5
- 260 - Mills oval 3-5
- 270 - Extraordinary award plate
- 301 - Mills Vest Pocket
- 308 - Mills War Eagle 2 cherries pay 3
- 444 - Mills oval Bursting Cherry 3-10
- 445 - Jennings Duchess .
- 446 - Extrabelle
- 447 - Paper War Eagle 3-5
- 448 - War Eagle, Blue Front variance
- 449 - War Eagle, Blue Front 2-5

DECALS

- 261 - Jennings
- 262 - Pace
- 263 - Mills
- 264 - Not available
- 265 - Watling
- 453 - Caille

JACKPOT CARDS

- 267 - Jackpot- \$15
- 268 - Jackpot- \$12
- 269 - Jackpot - \$8

HI-TOP AWARD CARDS

- 271 - With lock hole 3-5
- 272 - Without lock hole 3-5
- 273 - Wild Deuce 2-5 (not pictured)
- 275 - Without watermelons 2-5
- 276 - With watermelons 2-5 (not pictured)
- 277 - Bonus 2-5
- 278 - Mystery payout 2-5
- 450 - With lock hole 2-5
- 451 - Wide plastic 2-5
- 452 - Variance

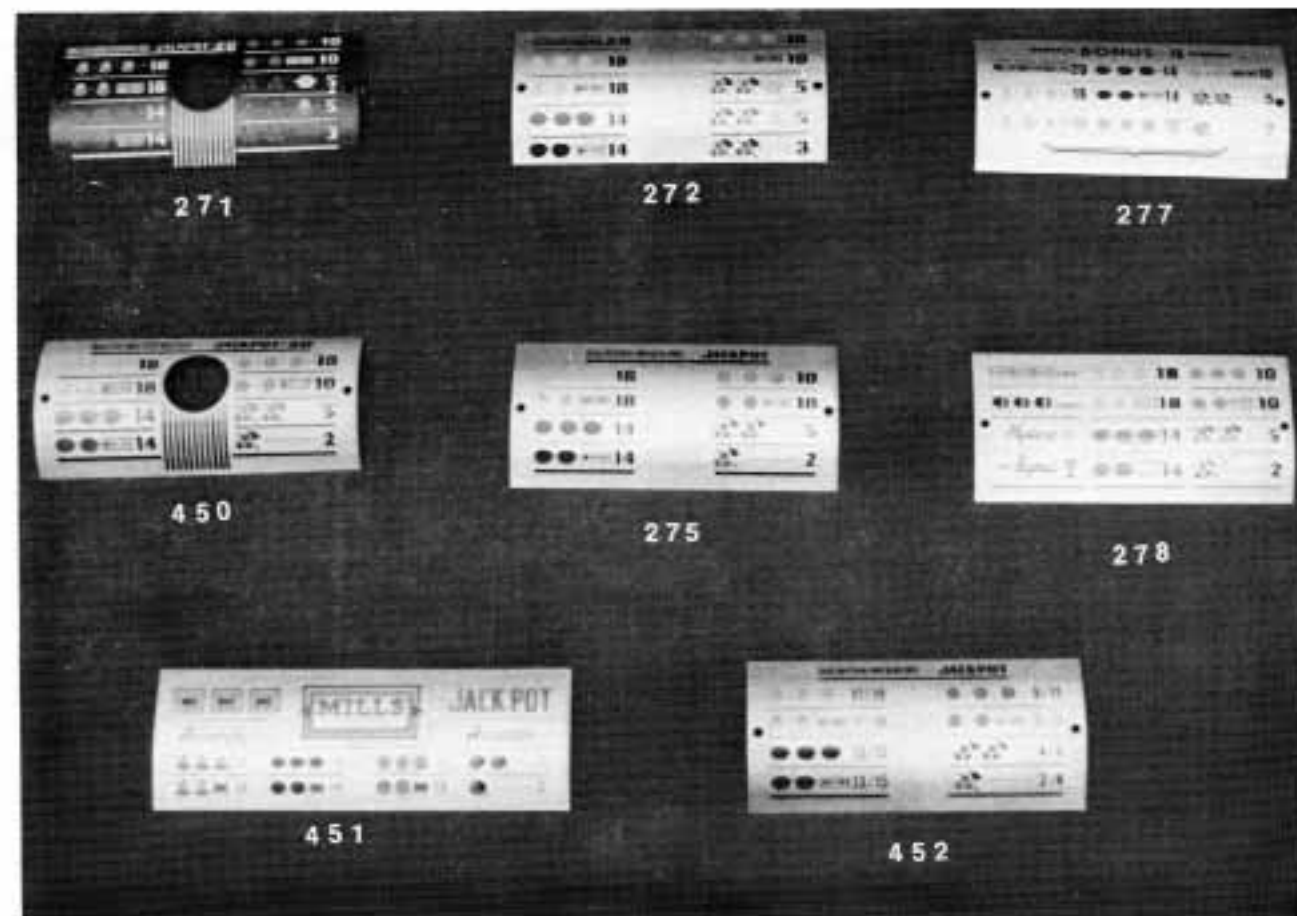

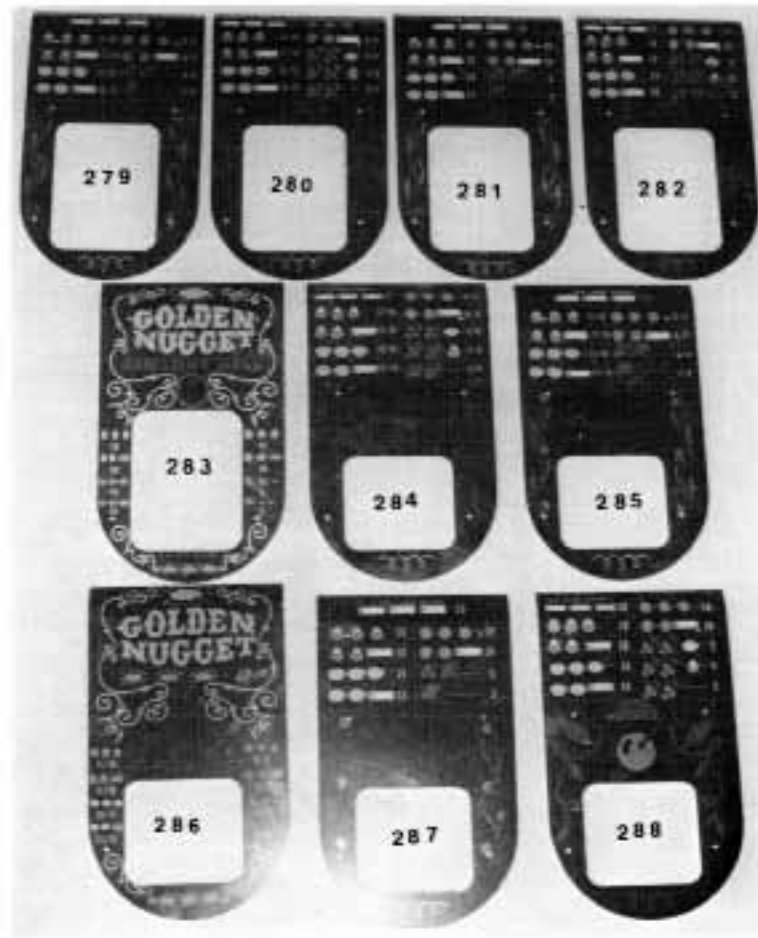

MILLS BIB AWARD CARDS (BLACK)

Wide mouth:

- 279 - Variance card 1 cherry pays 2-4
- 280 - Variance card 2 cherries pay 2-4
- 281 - 1 cherry pays 2
- 282 - 2 cherries pay 3
- 283 - Golden Nugget 1 cherry pays 2

Small mouth:

- 284 - Variance 2 cherries pay 2-4
- 285 - Variance 1 cherry pays 2-4
- 286 - Golden Nugget variance 1 cherry pays 2-4
- 287 - Black Cherry 1 cherry pays 2
- 288 - Black Cherry 2 cherries pay 3

MILLS STAINLESS STEEL AWARD CARDS

Wide mouth:

- 289 - 1 cherry pays 2
- 290 - 2 cherries pays 3

Small mouth:

- 291 - 1 cherry pays 2
- 292 - 2 cherries pays 3



BOOKS AND MANUALS

- 293 - Jennings parts manual
- 294 - Mills parts manual
- 295 - No longer available
- 297 - Pace service manual

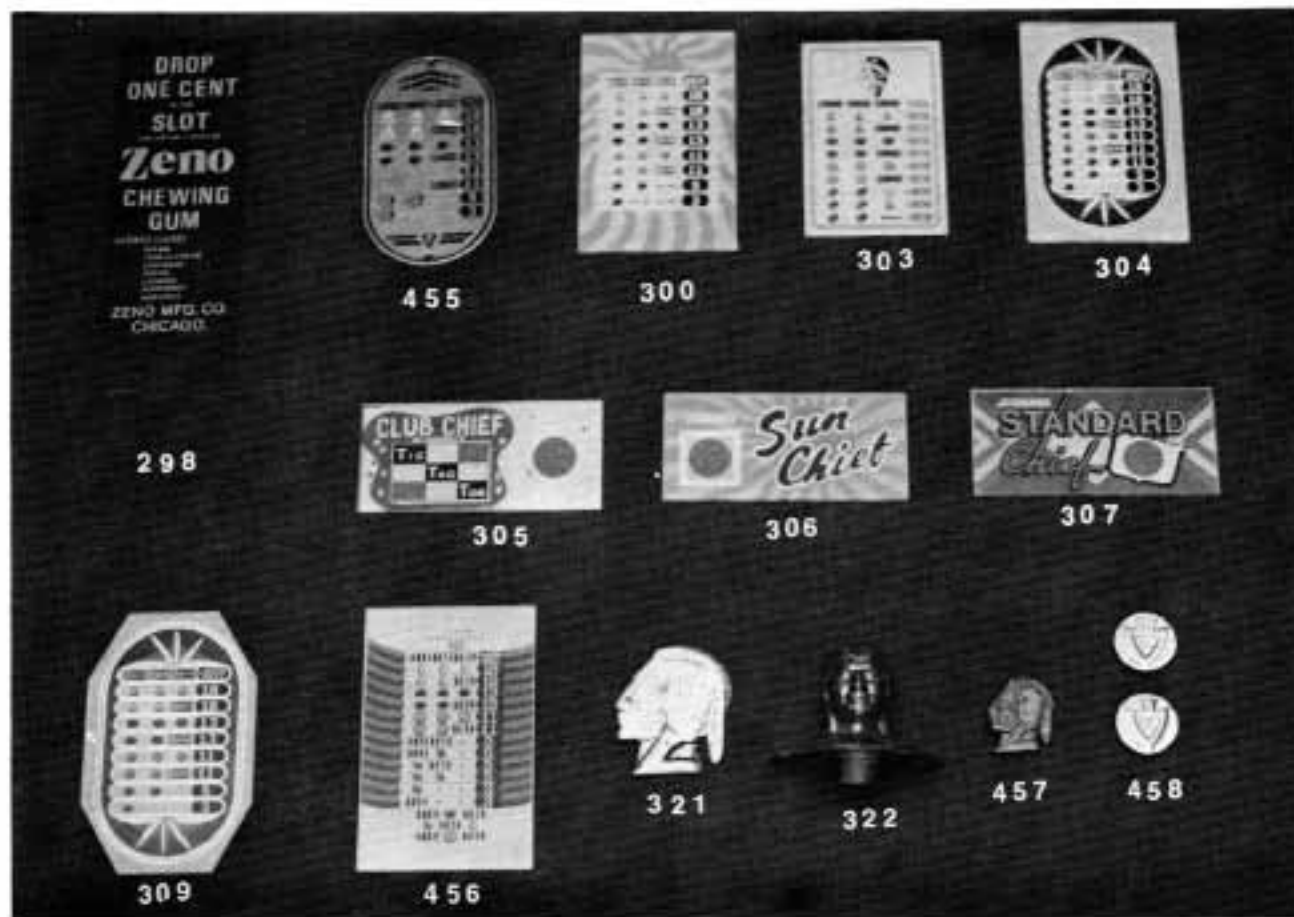

AWARD PLATES

- 298 - Zeno Gum award plates
- 300 - Jennings Sun Chief - plastic
- 303 - Jennings 4-Star - metal
- 304 - Jennings Standard Club Chief - plastic
- 305 - Jennings Club Chief Tic Tac Toe- plastic
- 306 - Jennings Sun Chief Denominator plate - plastic
- 307 - Jennings Standard Chief Denominator plate - plastic
- Note: For the above three specify decal 1¢, 5¢, 10¢, 25¢, 50¢
- 309 - Jennings octagon 3-5 - plastic
- 455 - Jennings oval - 1 cherry pays 3
- 456 - Jennings Tic Tac Toe- plastic

JENNINGS HARDWARE

- 321 - Jennings Brass flat Indian
- 322 - Jennings Brass Indian bust
- 457 - Jennings Brass little head
- 458 - Jennings arrows - specify chrome or brass

MISCELLANEOUS

- 324 - FOK vendor cover
- 325 - Watling base plate
- 326 - Mills right frame
- 327 - Mills A frame
- 328 - Mills mechanism base plate clips
- 329 - Mills base plate
- 330 - Mills sub plate

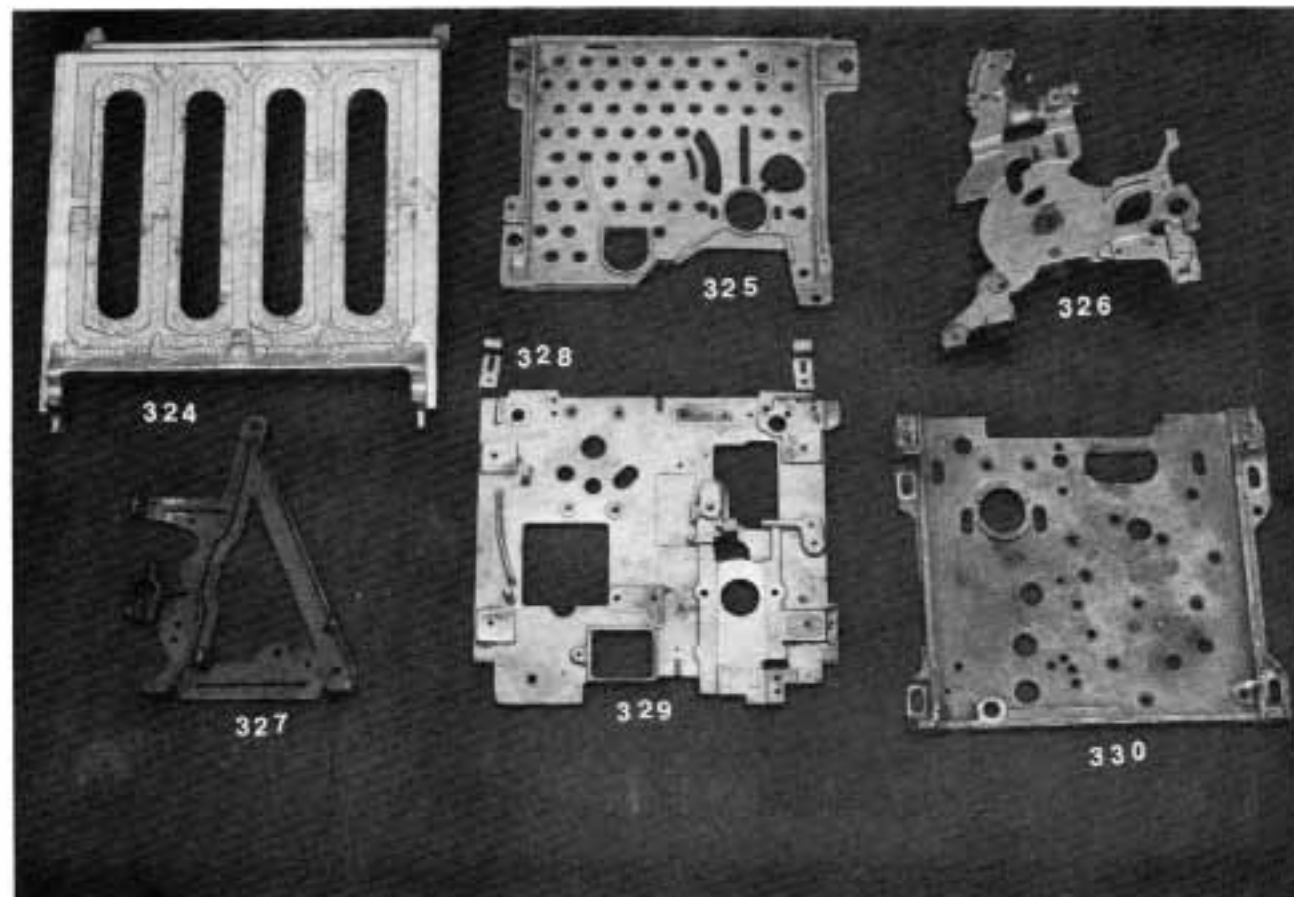

MILLS

PAPER AWARD CARDS

MILLS

- AC - 1 - Gold Award for War Eagle, Blue Front, Roman Head, 2-4 pay
- AC - 2 - Gold Award for War Eagle, Blue Front, Roman Head, 3-5 pay
- AC - 3 - Regular War Eagle, Blue Front, Roman Head, 3-5 pay
- AC - 4 - Regular War Eagle, Blue Front, Roman Head, 2-4 pay
- AC - 5 - War Eagle, Single Cherry, 2-5 pay
- AC - 6 - Poinsetta, 2-4 pay
- AC - 7 - Poinsetta, 3-5 pay

AC-1
SPECIAL GOLD AWARD
 3 War Eagle (Blue Front) = 20
 3 War Eagle (Blue Front) = 20
 3 War Eagle (Blue Front) = 16
 3 War Eagle (Blue Front) = 16
 3 War Eagle (Blue Front) = 12
 3 War Eagle (Blue Front) = 12
 3 Roman Head = 8
 3 Roman Head = 8
 3 War Eagle (Blue Front) = 4
 3 War Eagle (Blue Front) = 4
 3 War Eagle (Blue Front) = 2

AC-2
SPECIAL GOLD AWARD
 3 War Eagle (Blue Front) = 20
 3 War Eagle (Blue Front) = 20
 3 War Eagle (Blue Front) = 18
 3 War Eagle (Blue Front) = 18
 3 War Eagle (Blue Front) = 14
 3 War Eagle (Blue Front) = 14
 3 Roman Head = 10
 3 Roman Head = 10
 3 War Eagle (Blue Front) = 5
 3 War Eagle (Blue Front) = 5
 3 War Eagle (Blue Front) = 3

AC-3
THIS TAKES JACK POT
 3 War Eagle (Blue Front) = 20
 3 War Eagle (Blue Front) = 18
 3 War Eagle (Blue Front) = 18
 3 War Eagle (Blue Front) = 14
 3 War Eagle (Blue Front) = 14
 3 Roman Head = 10
 3 Roman Head = 10
 3 War Eagle (Blue Front) = 5
 3 War Eagle (Blue Front) = 5
 3 War Eagle (Blue Front) = 3

AC-15
THIS TAKES JACK POT
 3 War Eagle (Blue Front) = 20
 3 War Eagle (Blue Front) = 18
 3 War Eagle (Blue Front) = 18
 3 War Eagle (Blue Front) = 14
 3 War Eagle (Blue Front) = 14
 3 Roman Head = 10
 3 Roman Head = 10
 3 War Eagle (Blue Front) = 5
 3 War Eagle (Blue Front) = 5
 3 War Eagle (Blue Front) = 3
 10 CONSECUTIVE MISSES SHOWING ON DIAL... 10

AC-5
THIS TAKES JACK POT
 3 War Eagle (Blue Front) = 20
 3 War Eagle (Blue Front) = 18
 3 War Eagle (Blue Front) = 18
 3 War Eagle (Blue Front) = 14
 3 War Eagle (Blue Front) = 14
 3 Roman Head = 10
 3 Roman Head = 10
 3 War Eagle (Blue Front) = 5
 3 War Eagle (Blue Front) = 2

AC-6
THIS TAKES JACK POT
 3 War Eagle (Blue Front) = 20
 3 War Eagle (Blue Front) = 16
 3 War Eagle (Blue Front) = 16
 3 War Eagle (Blue Front) = 12
 3 War Eagle (Blue Front) = 12
 3 Roman Head = 8
 3 Roman Head = 8
 3 War Eagle (Blue Front) = 4
 3 War Eagle (Blue Front) = 4
 3 War Eagle (Blue Front) = 2

AC-7
THIS TAKES JACK POT
 3 War Eagle (Blue Front) = 20
 3 War Eagle (Blue Front) = 18
 3 War Eagle (Blue Front) = 18
 3 War Eagle (Blue Front) = 14
 3 War Eagle (Blue Front) = 14
 3 Roman Head = 10
 3 Roman Head = 10
 3 War Eagle (Blue Front) = 5
 3 War Eagle (Blue Front) = 5
 3 War Eagle (Blue Front) = 3

MILLS

THIS TAKES JACK POT

	20
	16
	16
	12
	12
	8
	8
	4
	4
	2

AC-8

THIS TAKES JACK POT

	20
	18
	18
	14
	14
	10
	10
	5
	5
	3

AC-9

3 BARS..20 and JACKPOT

3 Bells	16
2 Bells, 1 Bar	16
3 Plums	12
2 Plums, 1 Bar	12
3 Oranges	8
2 Oranges, 1 Bar	8
2 Cherries, 1 Lemon	4
2 Cherries, 1 bell	4
2 Cherries	2

CC-176-5 12-25-31 4M

AC-10

PAPER AWARD CARDS

- AC - 8 - Lion Head, 2-4 pay
- AC - 9 - Lion Head, 3-5 pay
- AC - 10 - Printed Lion, 2-4 pay
- AC - 11 - Fruit Q.T.
- AC - 12 - Symbols Q.T.
- AC - 13 - Extraordinary, 2-4 pay
- AC - 14 - Extraordinary, 3-5 pay

JACK POT

	12
	8
	4
	2
	2
	2

CC-413 10 40

AC-11

JACK POT

	12
	8
	4
	2
	2
	2

CC-369 8-31-35 5M

AC-12

THIS TAKES JACKPOT

	20
	16
	16
	12
	12
	8
	8
	4
	4
	2

CC-122 3-43

AC-13

THIS TAKES JACKPOT

	20
	18
	18
	14
	14
	10
	10
	5
	5
	3

CC-122 3-40

AC-14

MILLS



AC-20



AC-22

5c Mills Mints
Your Nickel Buys

MILLS AUTOMA

DESIGNED TO STIMULATE THE SALE OF OUR GUM, MINTS AND MERCHANDISE

IMPORTANT
Before You Make a Purchase Through This Machine, Look in the Window Above and See Just What You Can Buy for Your Nickel.

THE U. S. GOVERNMENT EXCISE TAX

A Package 5c
Premium Coupons

TIC SALESMAN

YOU GET JUST WHAT THE INDICATOR READS

Coupons Received from the Machine Should Be Traded in for Merchandise as the Machine Will Not Vend Gum or Mints for Coupons.

HAS BEEN PAID ON THIS VENDER.

AC-23

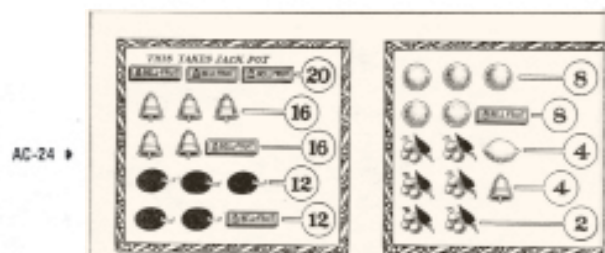

AC-24

WATCH REELS FOR YOUR FORTUNE

The Tokens received from this Vender have no value, but may be used to replay this Vender for the customer's sole amusement.

Watch the reels and have your fortune told.

CC-302 10-11-34 1M

YOUR NICKEL BUYS 5¢-----CANDY-----5¢

Deposit nickel and turn knob at lower right hand side to receive one 5¢ package of Vena.

A package of confectionery sends with each five cents. Confectionery not vendible with amusement tokens.

AC-28

Deposit Coin
Pull Handle
BE A BIG WINNER!

MILLS

HIT THE JACK-POT!
WATCH FOR REWARD!

AC-25

YOUR NICKEL BUYS A PACKAGE OF

5¢ Watch the Reels and Have Your Fortune Told 5¢

The Tokens received from this Vender have no value, but may be used to replay this Vender for the customer's sole amusement.

A package of confectionery sends with each five cents. Confectionery not vendible with amusement tokens.

TRY A PACKAGE OF

5¢ Watch the Reels and Have Your Fortune Told 5¢

Deposit nickel and turn knob at lower right hand side to receive one 5c package of Vena. Watch the reels and have your fortune told.

AC-27

PAPER AWARD CARDS

- AC - 15 - Futurity, 3-5 pay
- AC - 16 - Futurity Gold Award
- AC - 20 - FOK Play Nickels Only, center, 5" x 8-1/2"
- AC - 21 - FOK Play Nickels Only, Side
- AC - 22 - FOK, 5" X 8-1/2"
- AC - 23 - FOK Automatic Salesman, 5" x 8-1/2"
- AC - 24 - Conversion Front, 2-4 pay, 3" x 6"
- AC - 25 - Large FOK, 2-4 pay, 3-1/2" x 12-1/2"
- AC - 26 - Large FOK, 3-5 pay
- AC - 27 - Vendor FOK, 3-1/2" x 12-1/2"
- AC - 28 - Small FOK, 3-1/4" x 8-1/2"

PACE

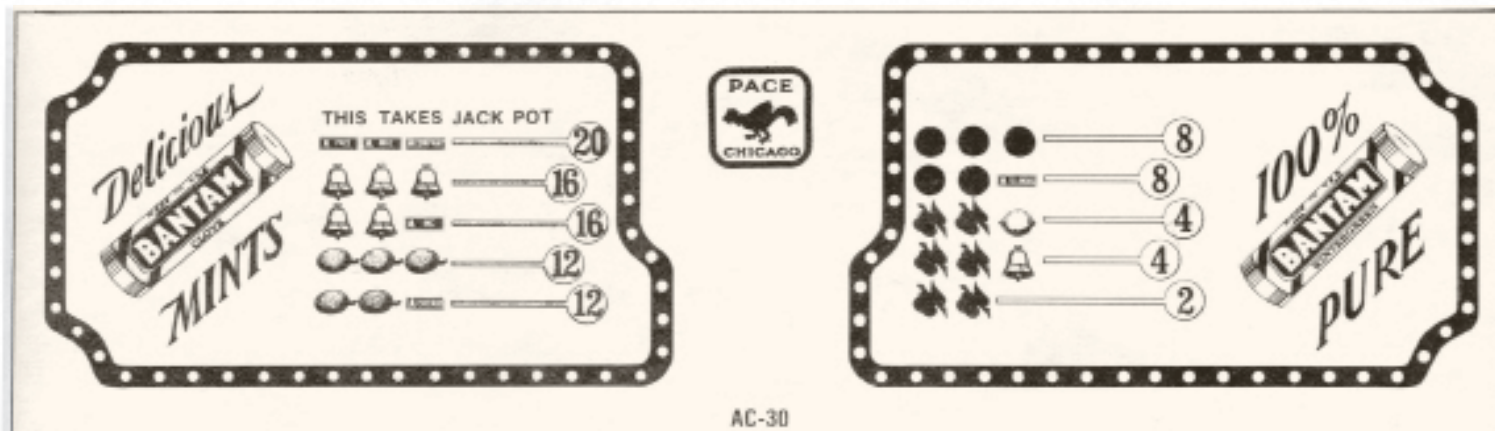

AC-30



AC-31

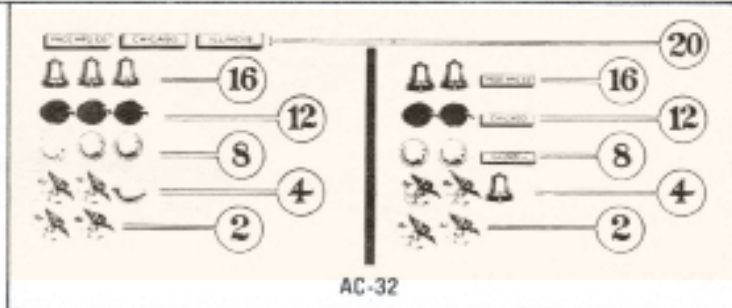

AC-32

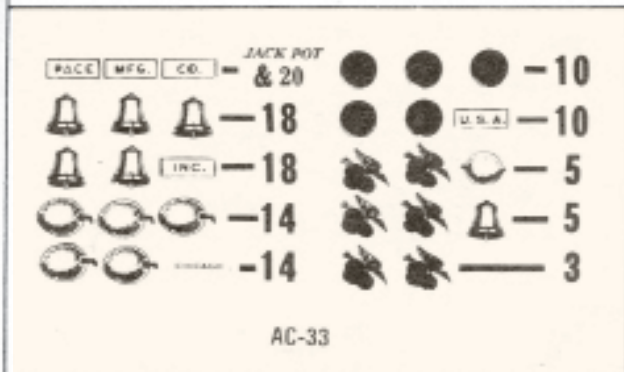

AC-33

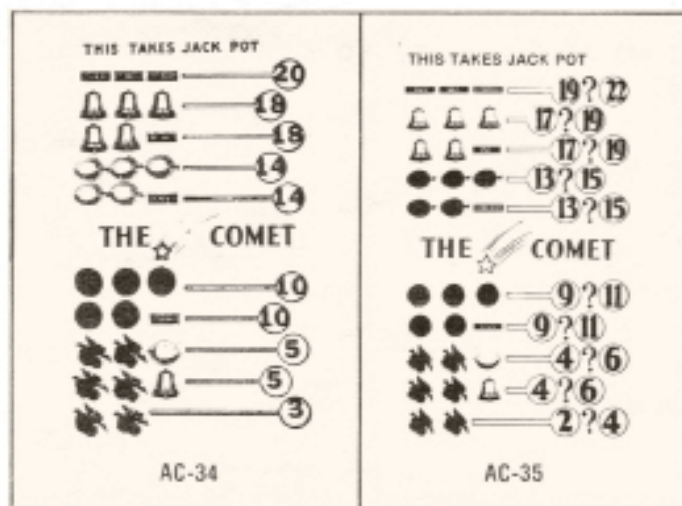

AC-34

AC-35

WATLING



AC-40

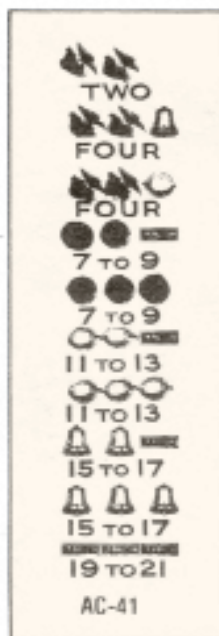

AC-41

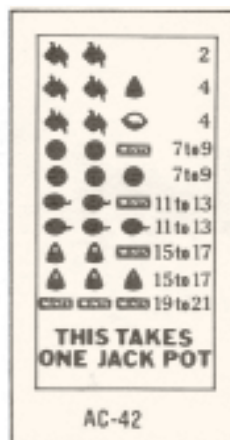

AC-42

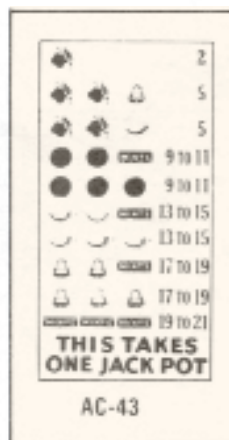

AC-43

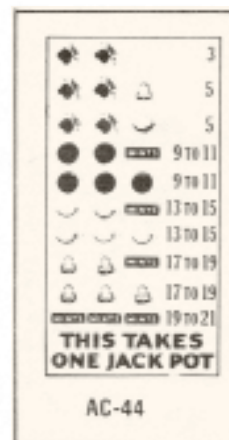

AC-44



AC-45

PACE

- AC - 30 - Pace Bantam Mints, 3-1/2" x 12-1/4"
- AC - 31- Pace Bantam, 3" x 6-1/4"
- AC - 32 - Pace Early large, 3" x 8"
- AC - 33 - Pace small, 2-1/2" x 5"
- AC - 34 - Comet, 3" x 5"
- AC - 35 - Comet variance, 2-5/8" x 3-1/2"

PAPER AWABD CARDS

WATLING

- AC - 40 - Win one of the Jackpots
- AC - 41 - Payout is under the fruit
- AC - 42 - 2-4 pay
- AC - 43 - Single Cherry, 2-5 pay
- AC - 44 - 3-5 pay
- AC - 45 - Gold Award 3-5 pay
- AC - 46 - Gold Award 2-4 pay

SPECIAL GOLD AWARD

AC-50

100

19 to 21

17 to 19

17 to 19

13 to 15

13 to 15

9 to 11

9 to 11

4 to 6

4 to 6

3

AC-51

JENNINGS

FIVE CENT PLAY

FOLLOWING COMBINATIONS PAY REWARDS AS SHOWN BELOW:

JACKPOT

18

13

11

5

3

N.B. Rewards only paid when spots or signals are shown on reels in exact position as on reward cards. Reverse position pays nothing.

5 Cent Play

FOLLOWING COMBINATIONS PAY REWARDS AS SHOWN BELOW:

JACKPOT

20

16

12

8

4

2

N.B. Rewards only paid when spots or signals are shown on reels in exact position as on reward cards. Reverse position pays nothing.

L. B. 799-A

JENNINGS

- AC - 50 - Special Gold Award
- AC - 51 - Early Victoria, Five Cent Play, 3-5 pay
- AC - 52 - Early Victoria, Quarter Play, 2-4 pay
- AC - 53 - Early Victoria, Half Dollar Play, 2-4 play
- AC - 54 - Nickel Play, 2-4 pay, 4-1/2" x 5-1/2"
- AC - 55 - Five Cent Play
- AC - 56 - Twenty Five Cent Play

LITTLE DUKE

- AC - 60 - Little Duke, One Cent Play
- AC - 61 - Little Duke, Five Cent Play

NICKEL Five Cent Play NICKEL

Gets 20 Trade Checks

Gets 16 Trade Checks

Gets 12 Trade Checks

Gets 8 Trade Checks

Gets 4 Trade Checks

Gets 2 Trade Checks

AC-55

LITTLE DUKE

ONE CENT PLAY

FOLLOWING COMBINATIONS PAY REWARDS AS SHOWN BELOW:

2

4

8

12

16

20

JACK POT

N. B. Rewards only paid when spots or signals are shown on reels in exact position as on reward cards. Reverse position pays nothing.

CAILLE

- AC - 70 - Play Nickels - 3 reel
- AC - 71 - Play Dimes - 3 reel
- AC-72 - Play Quarters - 3 reel
- AC - 73 - Play Nickels- 4 reel, 3-1/4" x 10-3/4"
- AC-74 - Play Dimes - 4 reel
- AC - 75 - Play Quarters - 4 reel
- AC - 76 - Play Nickels- No Jackpot, 3-3/4" x 12"

AC-73

CAILLE

Play Nickels

REWARDS ARE PAID ONLY WHEN THESE COMBINATIONS ARE SHOWN ON REELS AND IN LINE WITH ARROW. REVERSE POSITIONS DO NOT PAY.

3 BARS IN LINE WINS THE **Jack-Pot**

THIS IS ADDITIONAL TO REGULAR REWARD

20

16

16

12

12

8

8

4

4

2

Play Nickels

RECEIVES 20

RECEIVES 16

RECEIVES 16

RECEIVES 12

RECEIVES 12

RECEIVES 8

RECEIVES 8

RECEIVES 4

RECEIVES 4

RECEIVES 2

REWARDS ARE PAID ONLY WHEN SPOTS ON REELS CORRESPOND WITH THOSE ON REWARD CARD. REVERSE POSITIONS DO NOT PAY.

CARD NO. 81 PRINTED IN U. S. A.

Play Nickels

RECEIVES 8

RECEIVES 8

RECEIVES 4

RECEIVES 4

RECEIVES 2

AC-80

MISCELLANEOUS

- AC - 80 - Fortune Card, 3-1/2" x 5-1/2"

AC-76

MILLS

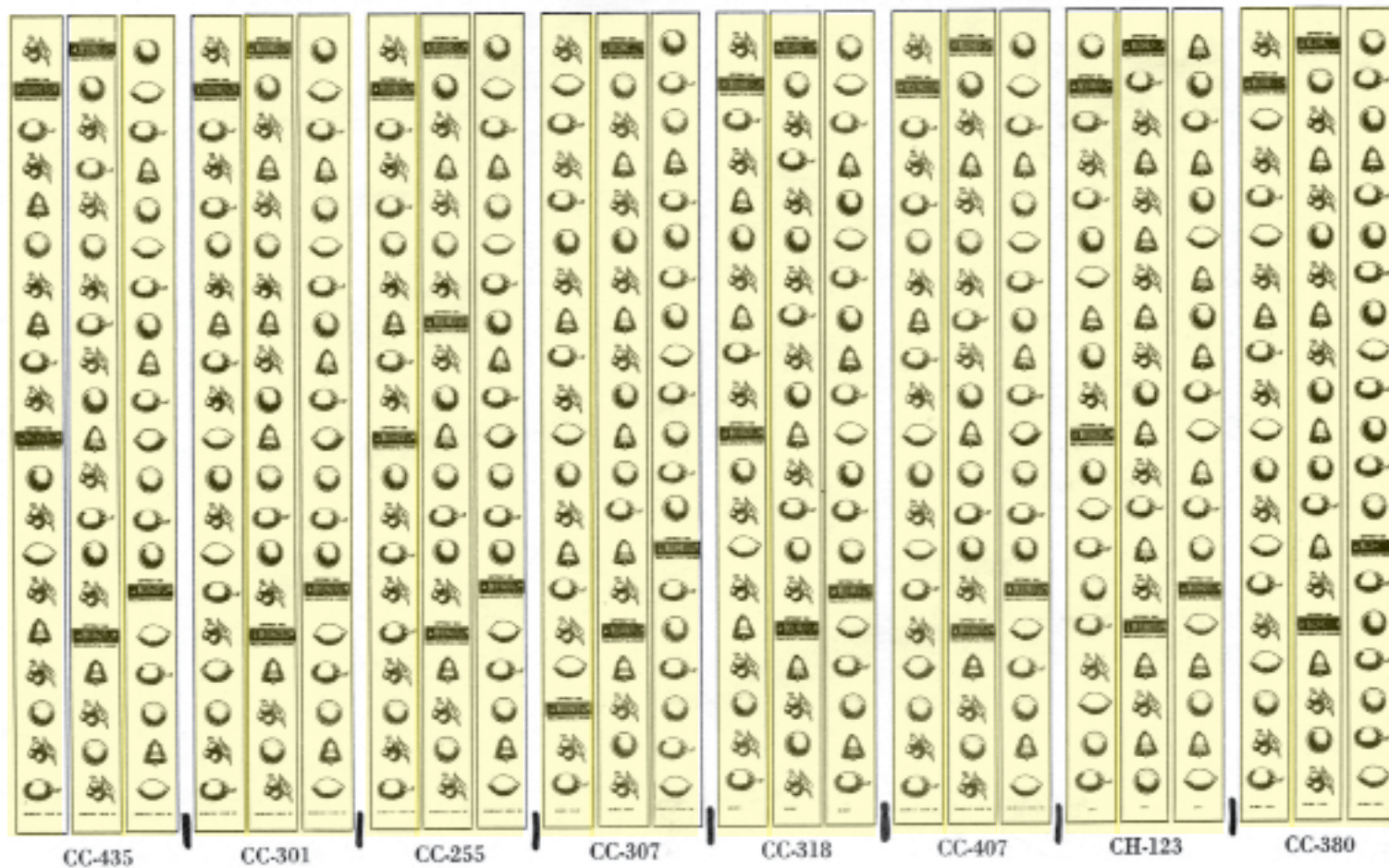
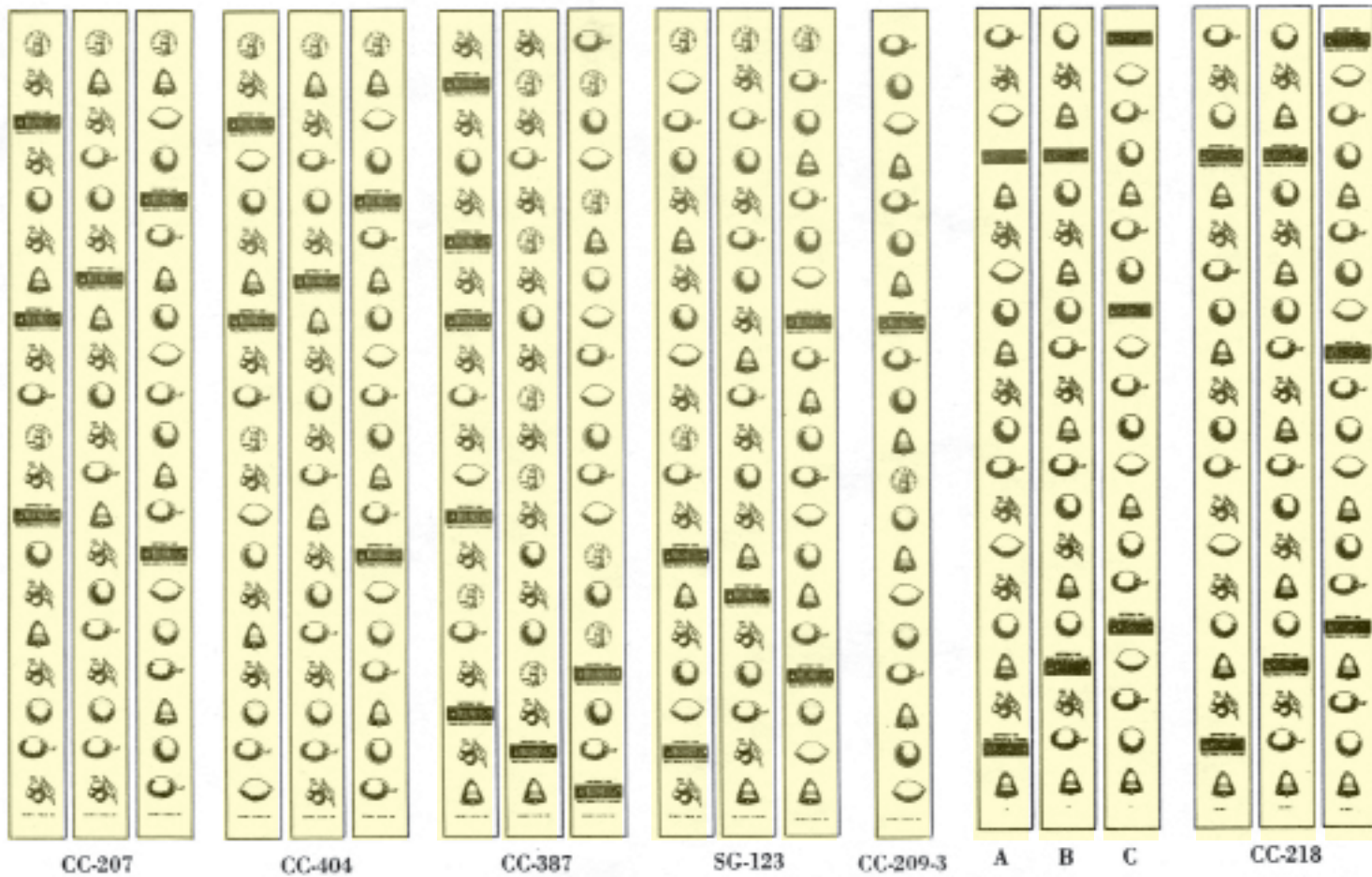

REEL STRIPS

CC STRIPS - \$25 SET

- All buff in color
- lacquer like glossy finish
- \$9 individual strip

CC strips include the Watling & Treasury Rol-A-Top sets (W-1, W-2, W-3) and the Jennings sets (J-1, J-2, J-3, J-4, J-5).

CC strips include the Watling & Treasury Rol-A-Top sets (W-1, W-2, W-3) and the Jennings sets (J-1, J-2, J-3, J-4, J-5).

CC strips available- not pictured:

- Mills Fortune
- Mills Vest Pocket (4 strips)
- Mills Puritan Mills Q.T. Fruit Mills Q.T. Symbols
- Little Duke Standard (\$27)
- Little Duke Fortune (\$27)

Strips without CC numbers - \$15 set

- available in buff, gold or silver in many of the sets
- \$5 individual strip

Strips available - not pictured

- Mills original Criss Cross
- Buckley & Mills Criss Cross
- Pace Comet Plain
- Pace Bantam 10 stop
- Pace Comet Fortune
- Black Golden Nugget
- Watling 10 Stop
- Superior 10 Stop
- Jennings Dutchess D-12 Fortune
- Caille 10 Stop

More strips available upon request.

Patches available upon request.

WATLING ROL-A-TOP & TREASURY

MILLS

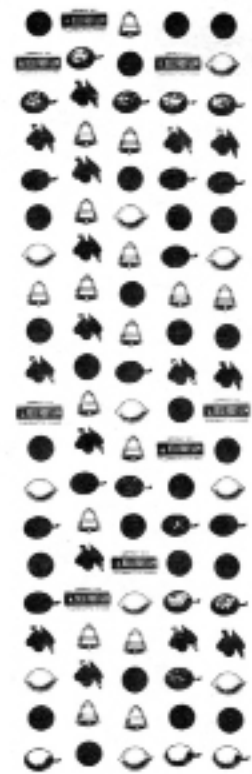

MILLS-CH SET

537-1, 537-2, 537-3, 539, 540



10 STOP PLAIN



10 STOP FORTUNE



S.P. FORTUNE



S.P. PLAIN



CC-319

W-1 STANDARD 20 STOP STRIPS



W-2



W-3 GOLD AWARD 20 STOP STRIPS

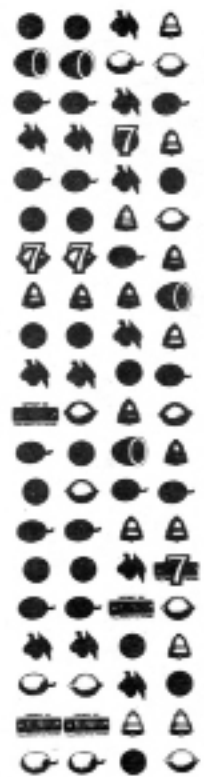

E.J. TRIPLE 7
EJ-1, EJ-1B, EJ-2, EJ-3
Silver only



WILD DELUCE
19-1, 19-3, CHAZ, OCH
Silver only

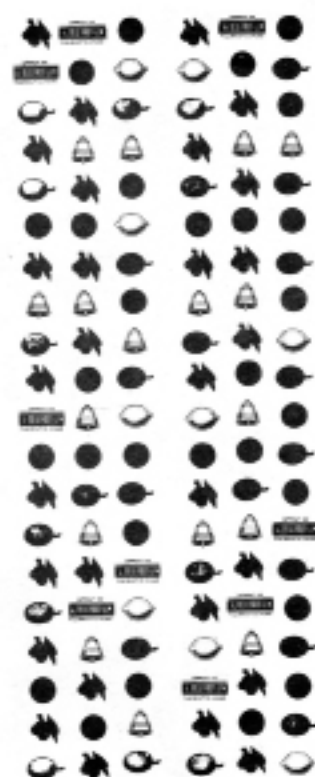

CC-538
SP-1, J-2, P-3



CC-407
J-1, J-2, J-3



CC-207-GOLD AWARD
G1, SG-1, G-2, G-3



HORSE BONUS

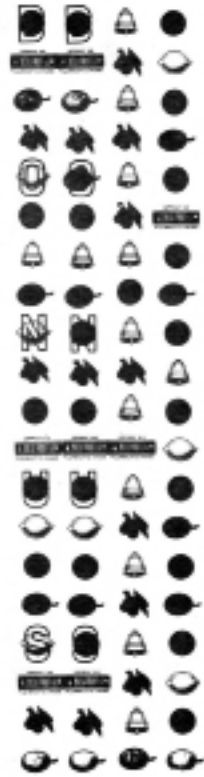

HI-TOP BONUS



Y1000 Y1000 Y1000



Y1000 Y1000 Y1000



Y1000 Y1000 Y1000



Y1000 Y1000 Y1000 Y1000



Y1000 Y1000 Y1000

JENNINGS

JENNINGS

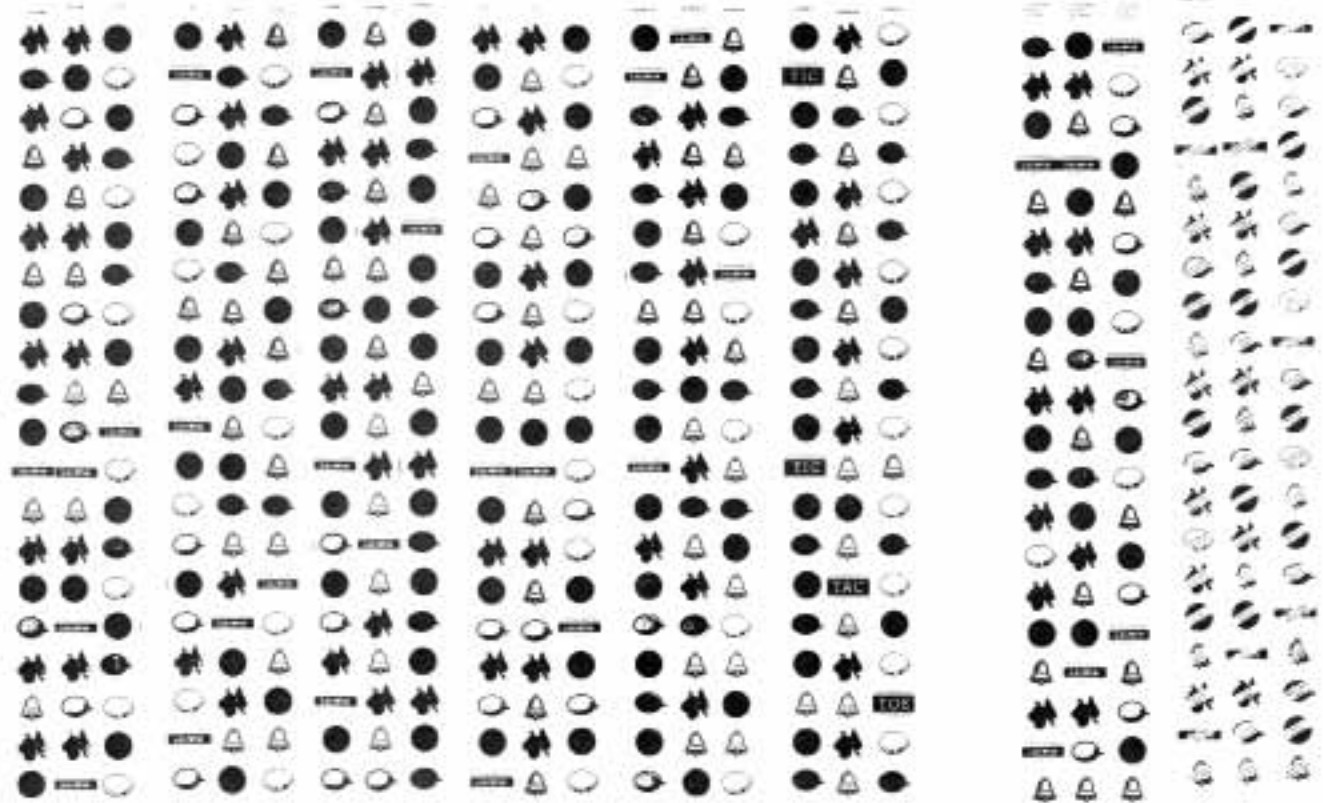

V-12-54 V-12-55 V-12-70 V-12-80 V-12-82XX V-12-92



V-12-23 SPECIAL Z3C, Z3B, Z3A, Z4C, 43C
LB B3 MPS
TODAY TY-670

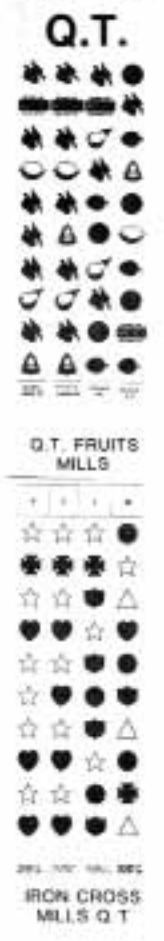

10 STOP PLAIN
10 STOP FORTUNE
VEST POCKET
MILLS VEST POCKET STRIPS
COLUMBIA



10 STOP-13/16 COLUMBIA
20 STOP COLUMBIA
20 STOP-11/16 COLUMBIA



PLAQUE
Made of plaster in the shape of company logo.
P-1 Mills
P-2 Watling
P-3 Pace
P-4 Caille



DARTBOARD
English Mark Darts - Home Electronic Dart Game includes electronic scoring, plastic tipped darts, four games, accessories and instructions included. 20" x 27"

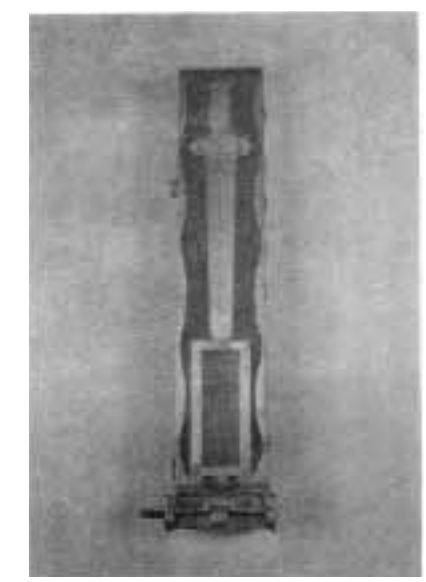

SIDE VENDOR Reproduction for Mills

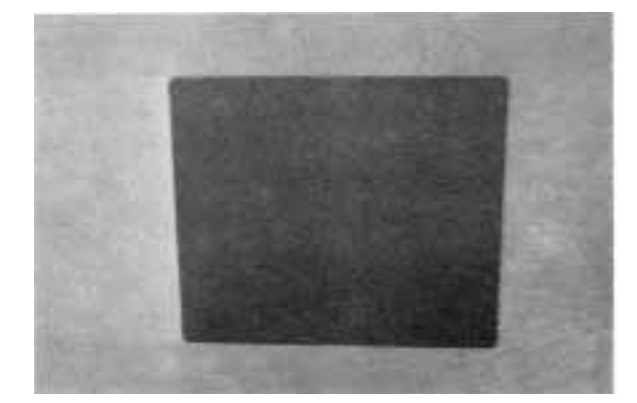

SLOT PAD- rubber mat used to keep slot machine in place and to protect table or stand.

467 - Gooseneck Magnifying Glass - Mills
468 - Gooseneck Magnifying Glass - Jennings

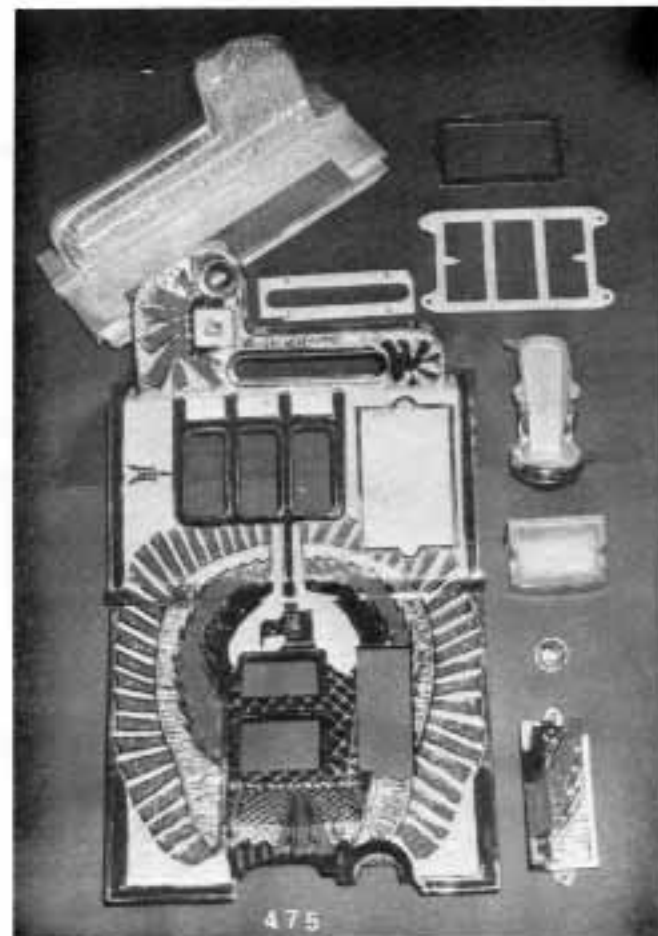
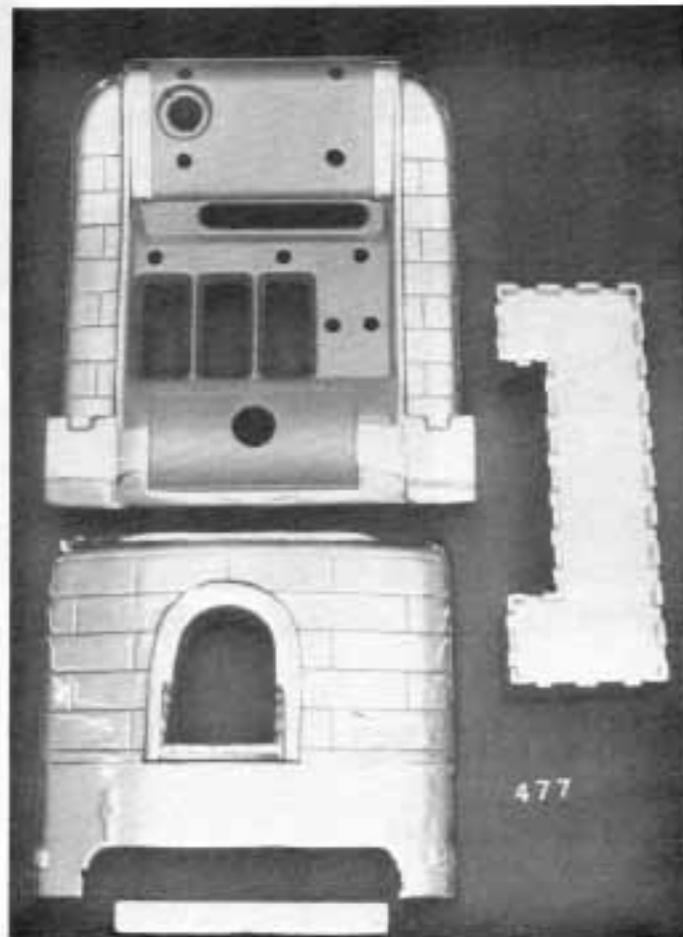

CASTING SETS

475 - War Eagle Kit

This kit includes all items as pictured AND a back door and an unfinished oak cabinet. The castings are drilled, tapped, chrome plated and painted.

476 - War Eagle Kit

This kit includes all items as pictured AND a back door and an unfinished oak cabinet. The castings are drilled, tapped, chrome plated and UNPAINTED.

477 - Silver Palace Kit

This kit includes four pieces as pictured. All pieces are drilled, tapped and chrome plated.

478 - Silver Palace Kit

This kit includes four pieces as pictured. All pieces are drilled, tapped but UNPLATED.

479 - Hi-Top Casting Kit

This kit includes the castings as pictured drilled and tapped.

480 - Extra-belle Casting Kit

This kit includes all items as pictured AND a back bonnet. The castings are drilled, tapped and polished.

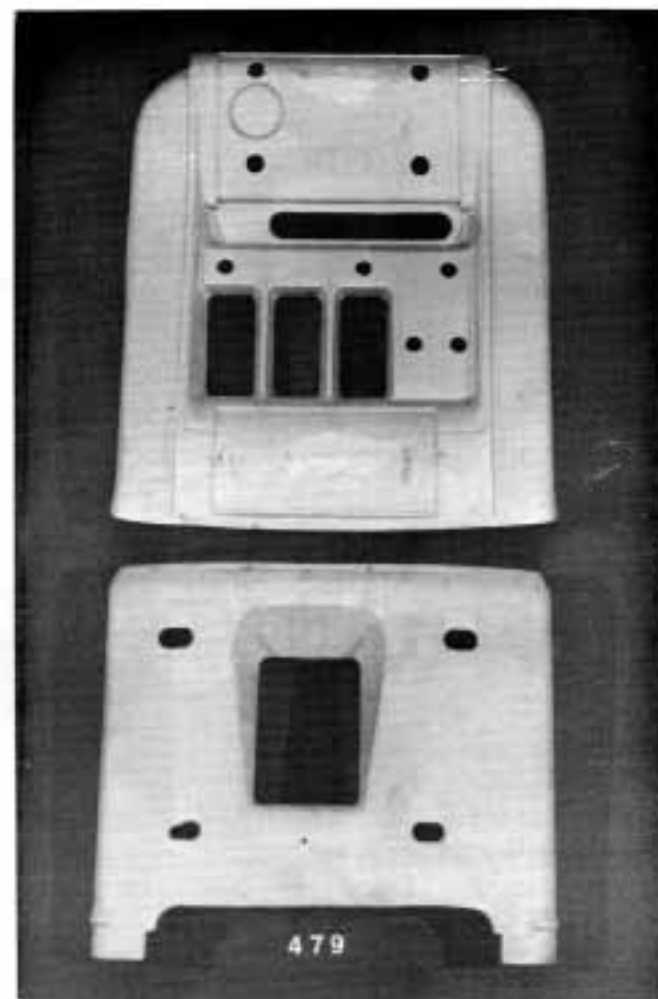
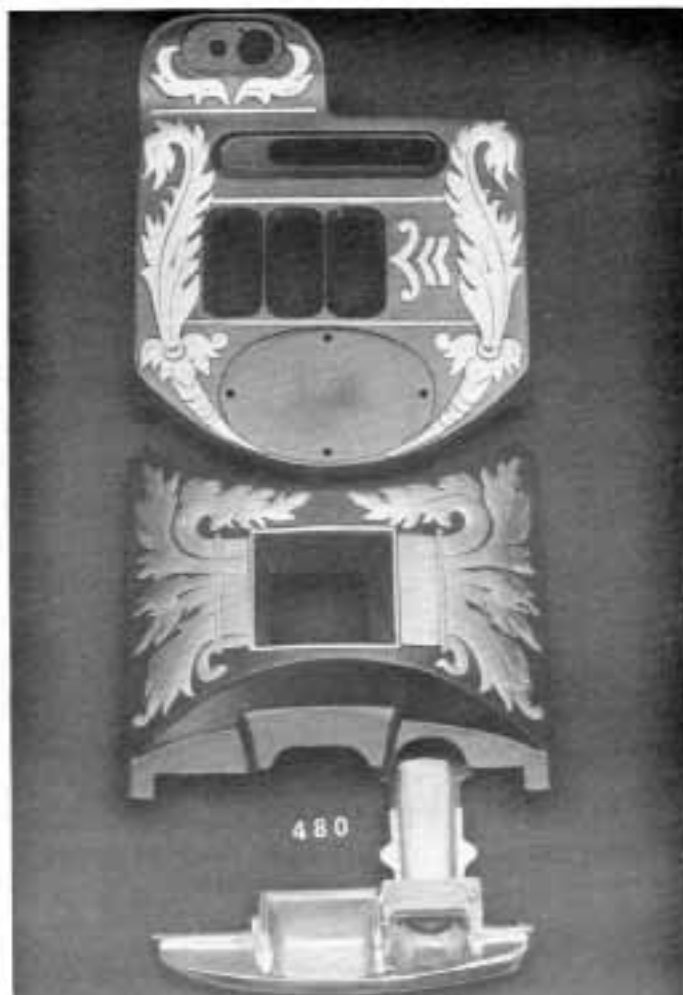



ST3B- Wood Plaque Lady-Brass



ST7B - Frosted Plaque Lady



ST9B - Rose Leaded Glass



ST11B - Frosted Jeweled Glass



ST12B- Wood Indian Head-Brass
OAK SLOT MACHINE STANDS



S713B - Bally's Lighted Glass-No Door

OAK SLOT MACHINE STANDS

OAK STAND FEATURES:

- Six Styles to choose from
- Adjustable Shelves
- Locking Doors
- Four Polished Brass Feet

DIMENSIONS:

- Height: 34"
- Top Size : 17-1/2" x 17-1/2"

Stands can be shipped UPS.

OAK STAND FEATURES:

- Six Styles to choose from
- Adjustable Shelves
- Locking Doors
- Four Polished Brass Feet

DIMENSIONS:

- Height: 34"
- Top Size : 17-1/2" x 17-1/2"

Stands can be shipped UPS.



ST4B- Wood Owl - Brass



ST10B- Jeweled Glass



STSB - Slot Glass (Blue or Red)



ST14B- Deluxe Lion's Head Wood-Brass



ST15B - Deluxe Tulip Leaded



ST16B - Deluxe Wood Plaque Lady

MILLS PARTS in Detail

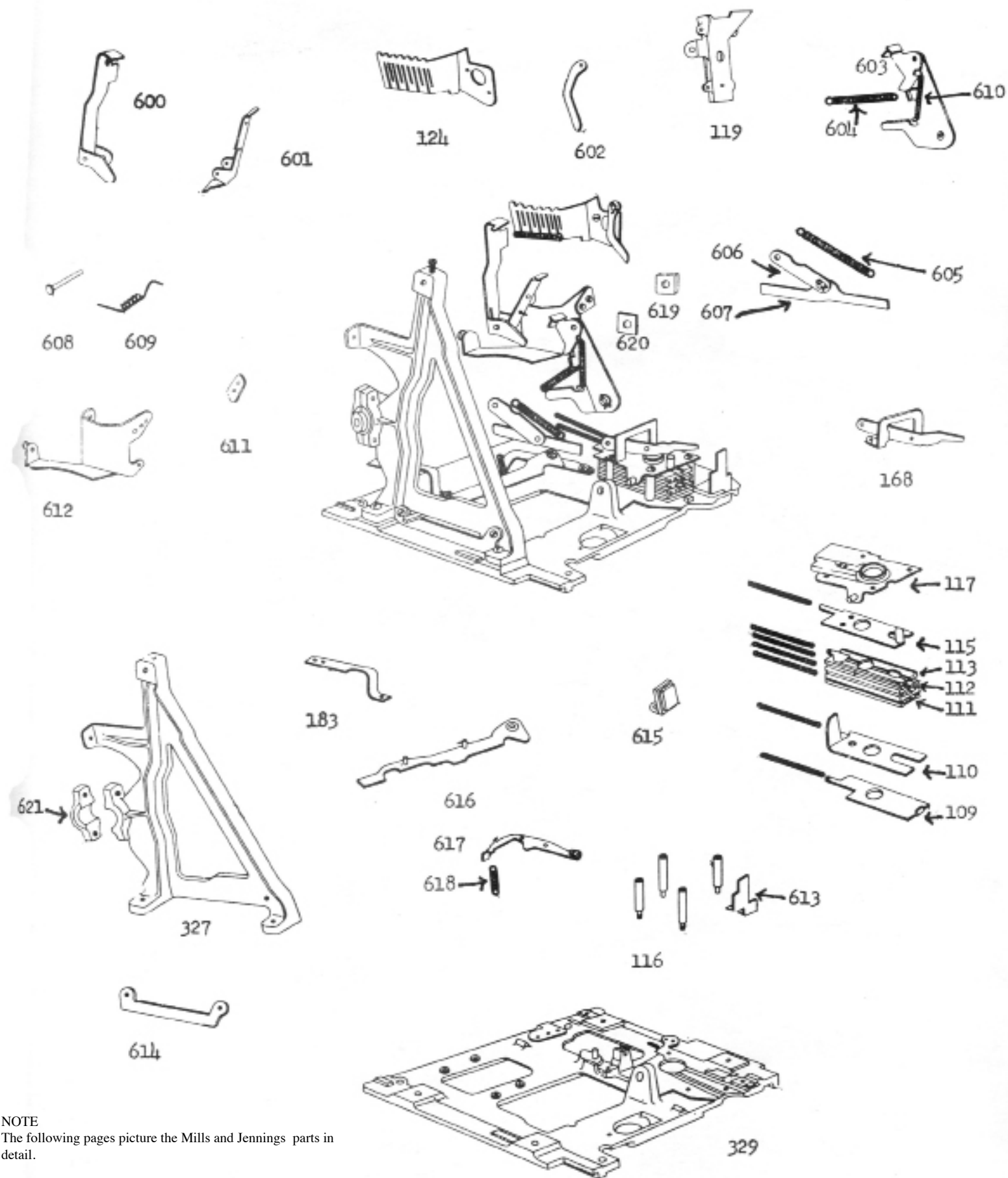

MILLS PARTS in Detail

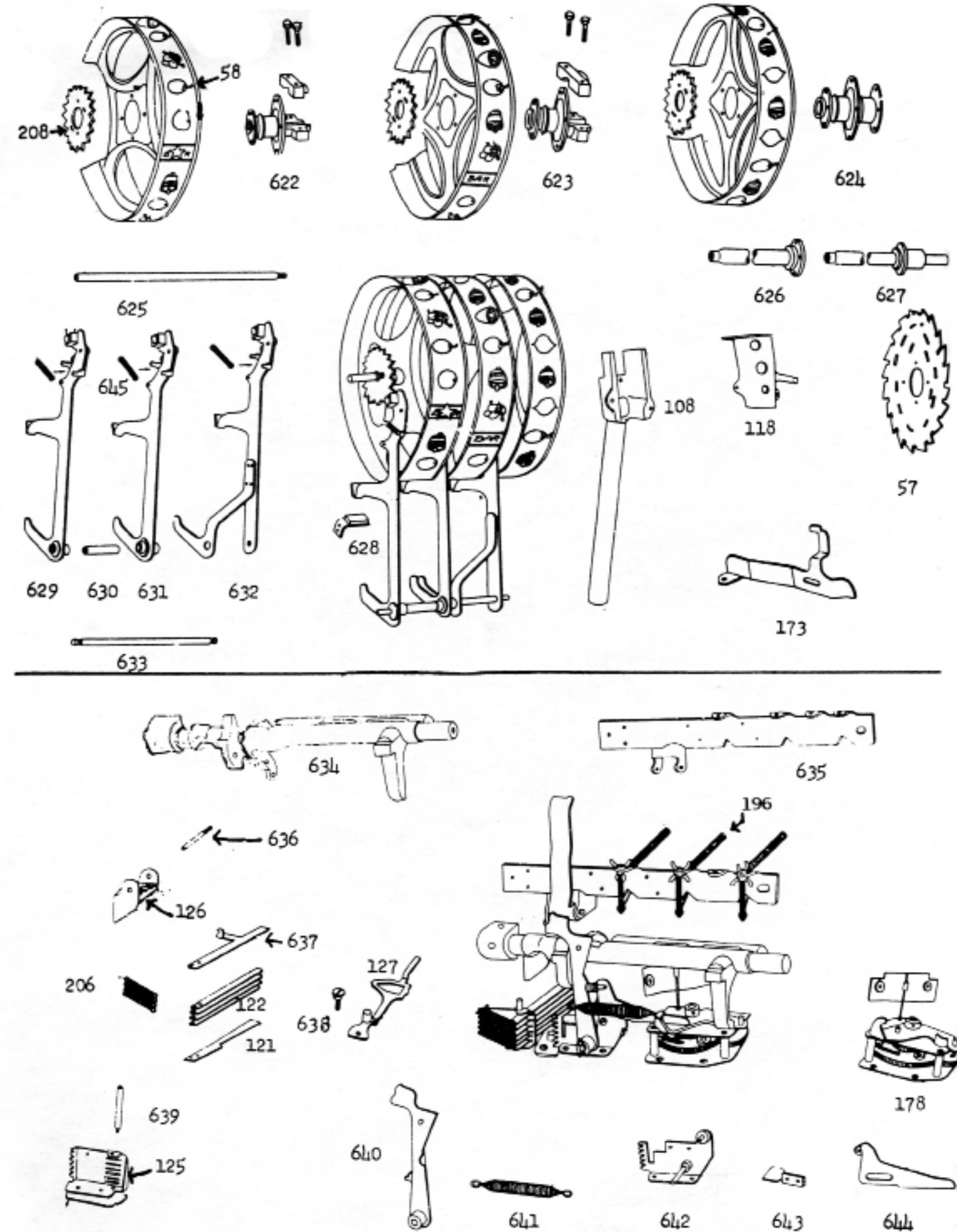

NOTE
The following pages picture the Mills and Jennings parts in detail.

The Jennings parts are described next to the page they are pictured.

MILLS PARTS in Detail

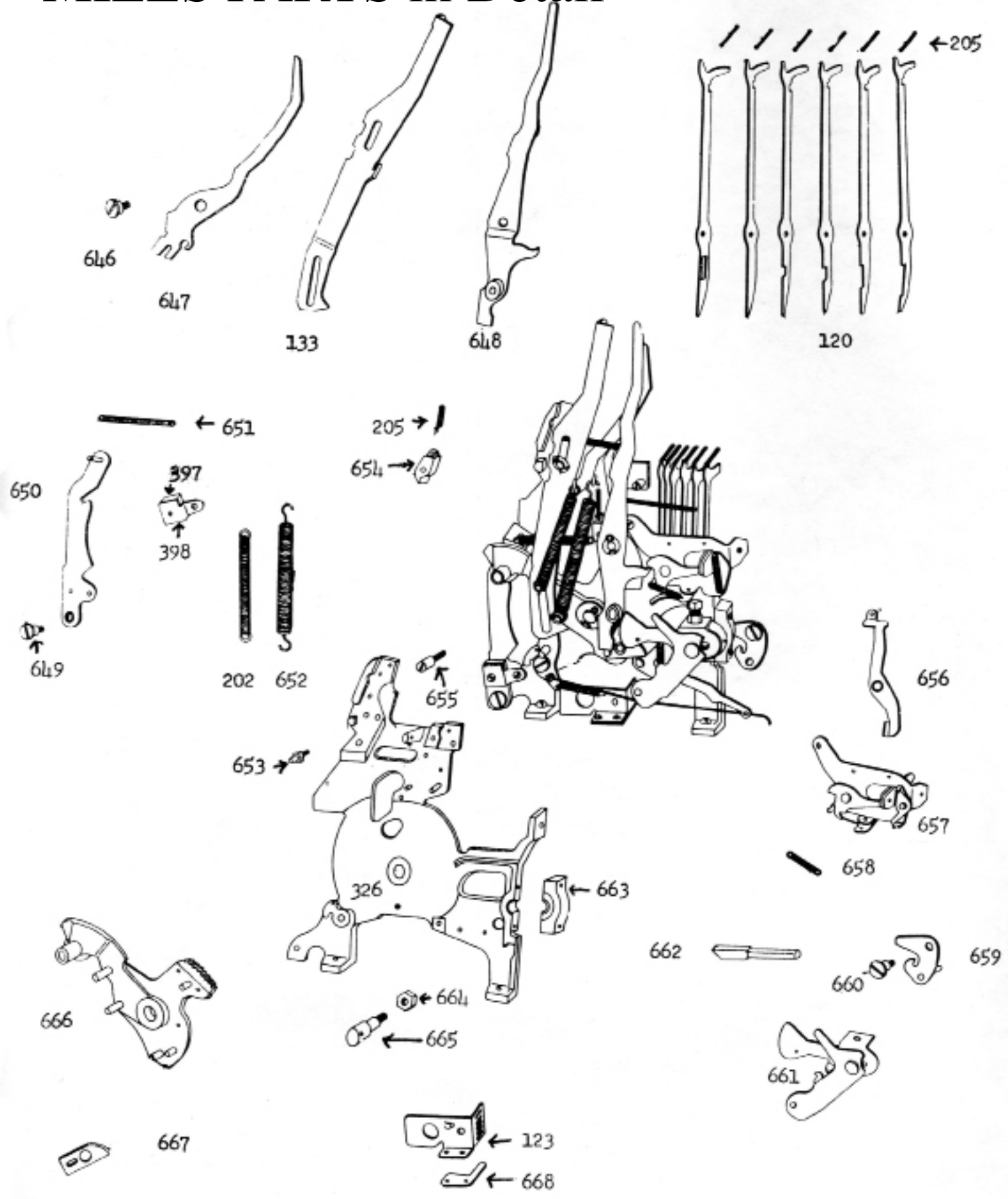

MILLS PARTS in Detail

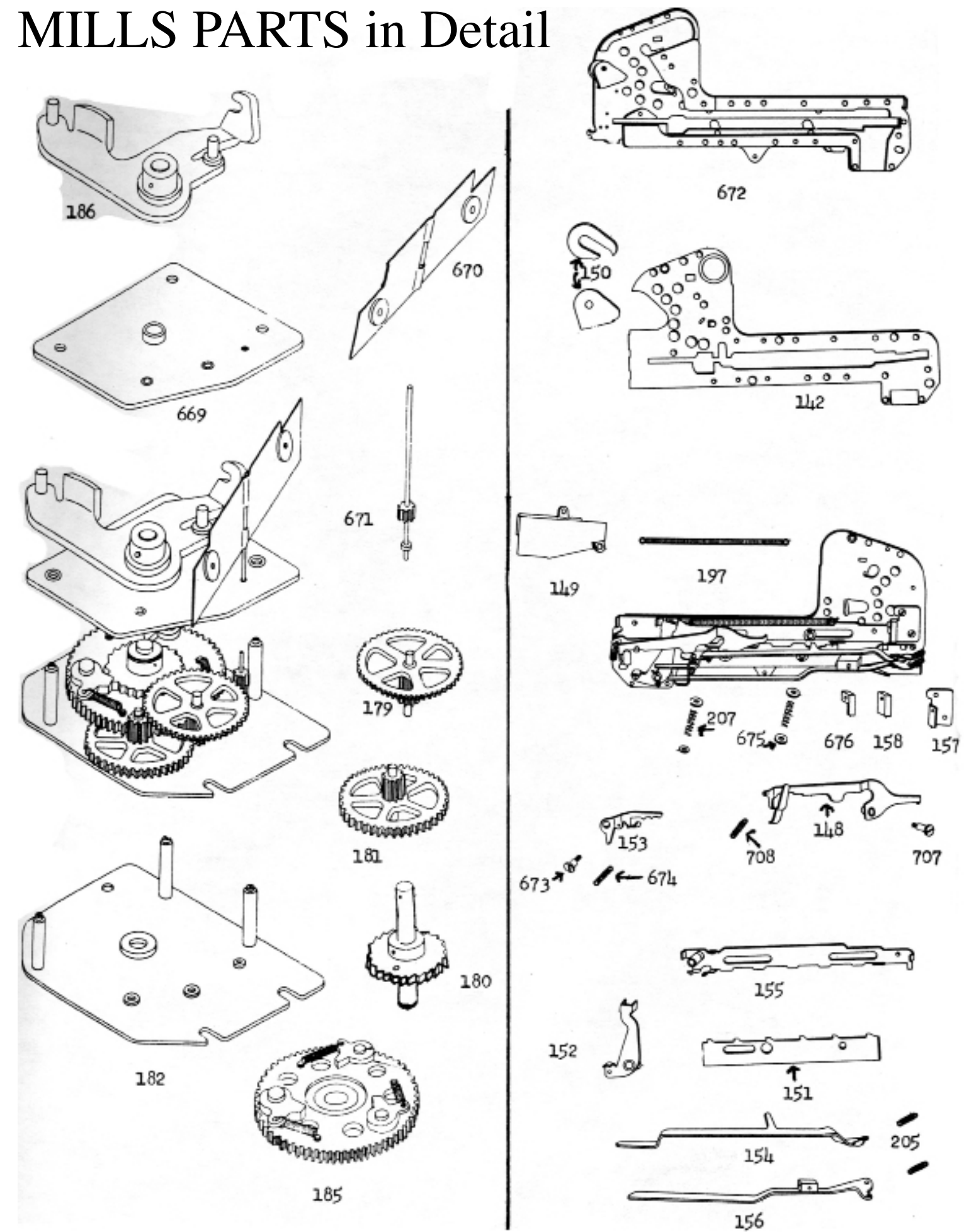

MILLS PARTS in Detail

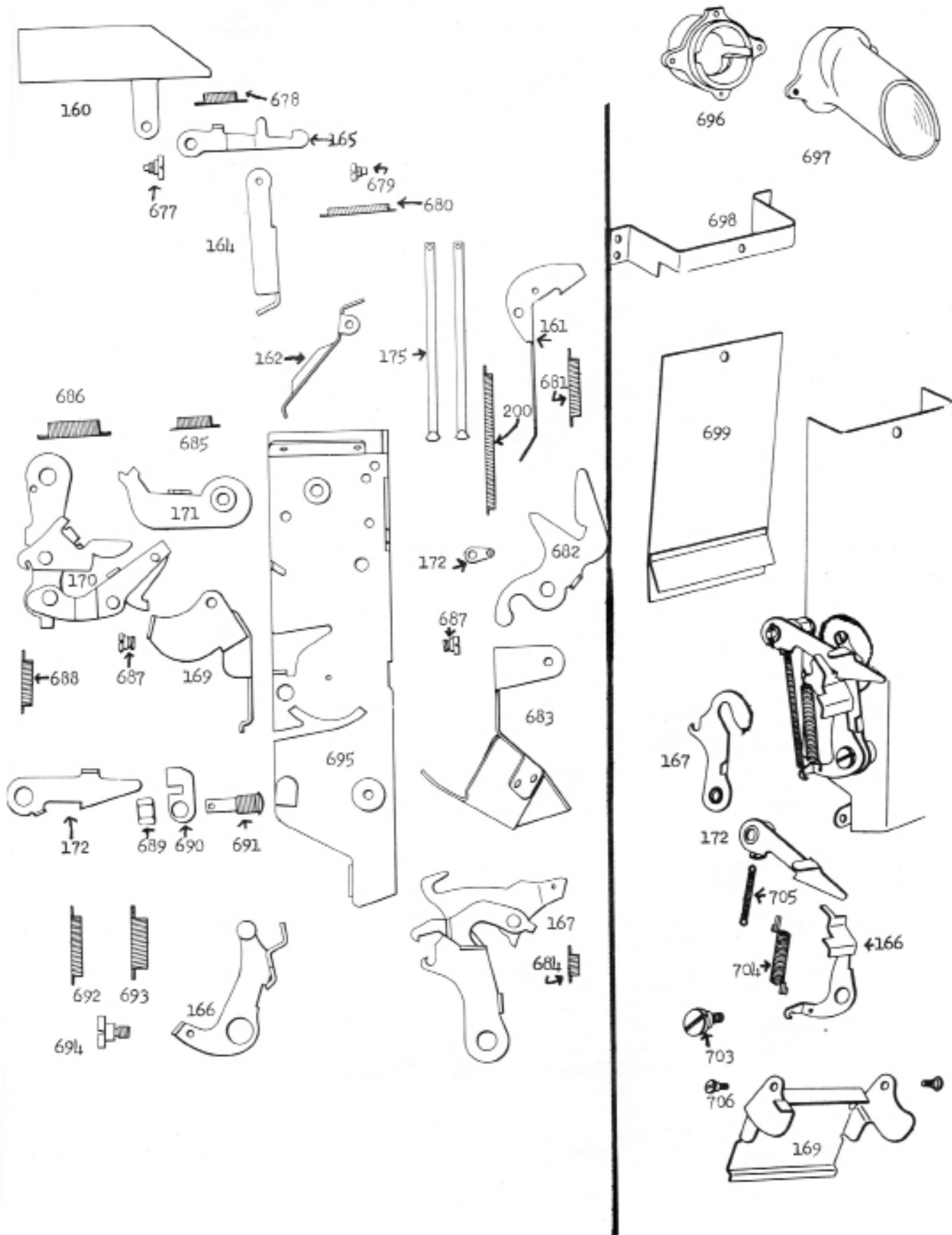

JENNINGS FRAMES



CABINET PARTS

FRAME ATTACHMENTS - REAR OF MECHANISM

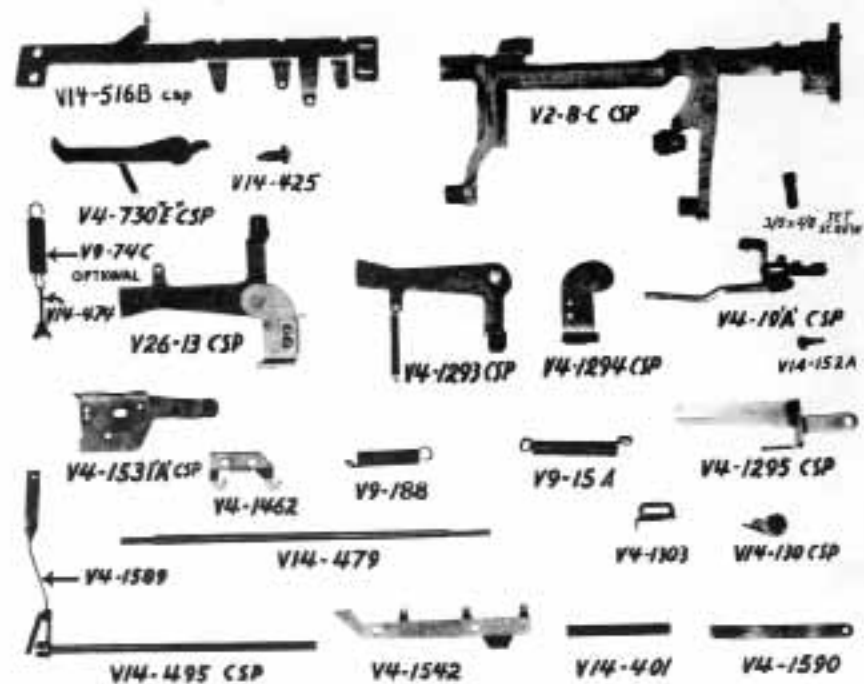

JENNINGS FRAMES

- V1 - 129 Standard Chief reel display
- V1 - 129A Club Chief reel display frame
- V4 - 202A Coin display glass frame
- V4 - 1523 Award card glass holder
- V4 - 1524 Name plate glass holder
- V4 - 1595 Standard Chief award card glass holder
- V4 - 1596 Standard Chief name plate glass holder
- VII - 8 Gasket for escalator glass

CABINET PARTS

- V1 - 38B CSP Aluminum base assembly
- V1 - 215 CSP Check pocket assembly
- V2 - 22 Handle collar
- V4 - 178 Complete pump assembly
- V4 - 222 CSP Inside handle plate assembly
- V4 - 413 CSP Handle operating cam assembly
- V4 - 414 CSP Right latch catch on cabinet
- V4 - 625 Bumper housing
- V4 - 626 Left latch catch
- V4 - 944L Left cabinet mounting safety catch
- V4 - 944R Right cabinet mounting safety catch
- V4 - 1526 Cabinet top left channel
- V4 - 1529 Cabinet top right channel
- V4 - 1732 Drill proof plate for V12-46
- V9 - 33B Handle return spring
- V10 - 40 Handle return spring wire loop
- VII - 17 Lower handle bumper
- VII - 18 Upper handle bumper
- V14 - 155 Hub bolt for hub V14-390
- V14 - 391 CSP Handle shaft assembly
- V26 - 3 Complete right latch assembly
- V26 - 4 Complete left latch assembly
- V26 - 16 Cash box

FRAME ATTACHMENTS REAR OF MECHANISM

- V2 - 8C Main operating lever assembly
- V4 - 19A Payout push rod safety arm assembly
- V4 - 730ECSP Disc back spin stopping lever assembly
- V4 - 1293 Payout lever cam arm assembly
- V4 - 1294 CSP Payout lever cam arm bracket assembly
- V4 - 1295 CSP payout lever cam arm guide assembly
- V4 - 1303 Payout lever cam arm adjuster
- V4 - 1462 Operating fork springs hook
- V4 - 1531A CSP Fork assembly for V2-8C
- V4 - 1542 Reel stop lever spring bracket
- V4 - 1589 Rod bracket lever
- V4 - 1590 Cam arm lever
- V9 - 15A Slide push rod spring
- V9 - 74C Reel spinner helper spring
- V9 - 188 Short slide push rod spring
- V14 - 130 CSP Coin escapement release arm hub assembly
- V14 - 152A Speed lock shoulder stud for V2-8C
- V14 - 401 Main operating lever lift pin
- V14 - 425 Shoulder screw for payout and disc back stop arm
- V14 - 474 Adjusting spring hook for reel drive sector
- V14 - 479 Bracer shaft
- V14 - 495 CSP Shaft assembly
- V26 - 13 CSP Payout lever cam arm & bracket assembly

LEFT SIDE FRAME , BASE AND ATTACHMENTS

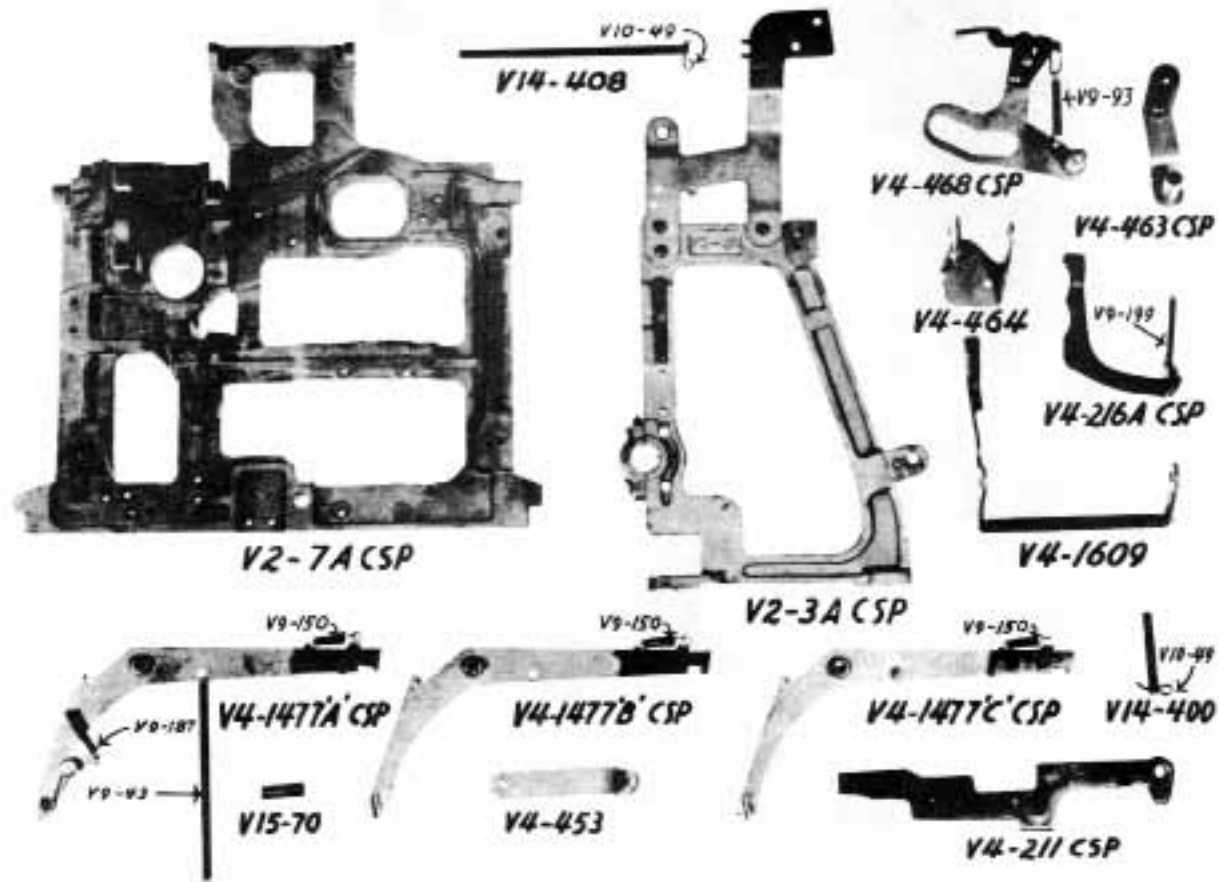

RIGHT SIDE FRAME AND ATTACHMENTS

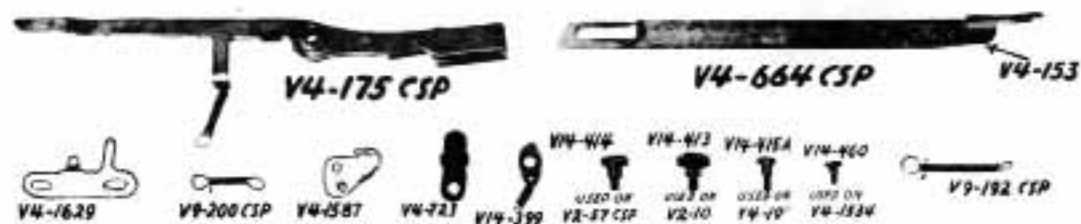
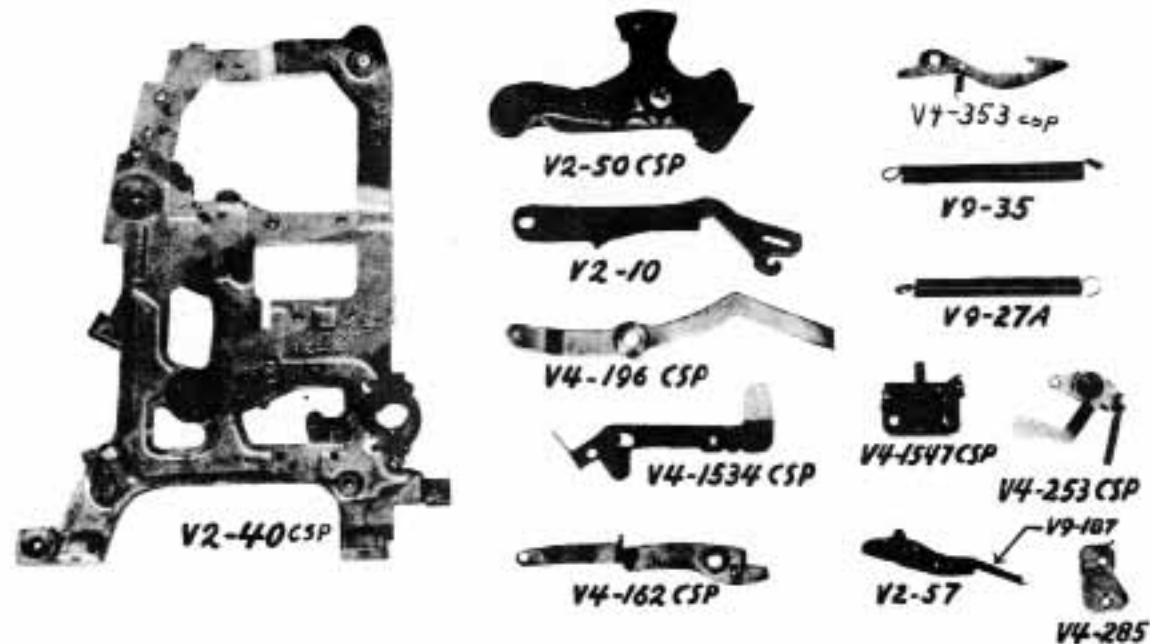

JENNINGS FRAME & ATTACHMENTS

- V2 - 3A CSP Left side frame assembly
- V2 - 7A CSP Chief base assembly
- V4 - 211 CSP Timing bar assembly
- V4 - 216A Payout lock lever assembly
- V4 - 453 Clock & timing bar connecting link
- V4 - 463 CSP Jackpot support bracket assembly
- V4 - 464 Jackpot lock lever bracket
- V4 - 468 CSP Complete reel spinner
- V4 - 1477C CSP Complete C Reel stop lever assembly
- V4 - 1477B CSP Complete B Reel stop lever assembly
- V4 - 1477A CSP Complete A Reel stop lever assembly
- V4 - 1609 Reel stop lefter arm
- V9 - 43 Reel stop lever springs
- V9 - 93 Spring for V4 - 468 CSP
- V9 - 150 Spring
- V9 - 187 Spring
- V9 - 199 Spring for V4 - 216A CSP
- V10 - 49 Reel spinner shaft holding pin
- V14 - 400 Reel spinner shaft
- V15 - 70 Stop lever bushing

RIGHT SIDE FRAME & ATTACHMENTS

- V2 - 10 Lock lever
- V2 - 40 Right side frame assembly
- V2 - 50 CSP Main drive lever assembly
- V2 - 57 Lock lever
- V4 - 153 Coin operating lever link extension
- V4 - 162 CSP Coin separator lever assembly
- V4 - 175 CSP Mint control lever assembly
- V4 - 196 CSP Peeler shaft drive lever assembly
- V4 - 253 CSP Non-repeating arm assembly
- V4 - 285 Spring hook
- V4 - 353 CSP No pay on check lock lever assembly
- V4 - 664 CSP Coin operating lever connecting link assembly
- V4 - 723 Spring pull clip
- V4 - 1534 CSP Arm assembly for reloading machine
- V4 - 1547 CSP No pay on check bracket assembly
- V4 - 1587 Rod guide bracket
- V4 - 1629 Push lever
- V9 - 27A Operating lever connecting link spring
- V9 - 35 Operating arm spring
- V9 - 187 Spring for V2 - 57
- V9 - 192 CSP Coil spring assembly
- V9 - 200 CSP Push lever spring assembly
- V14 - 399 Pawl for side frame
- V14 - 413 Lock lever shoulder screw
- V14 - 414 Shoulder screw for coin separator lever
- V14 - 415A Feeler shaft drive lever shoulder screw
- V14 - 460 Shoulder screw for V4 - 1534

